



Installation Manual



Document Number 21100-1 Rev A
October, 2000

Document Number 21100-1 Rev A
October, 2000
Copyright © 2000 HAI
All Rights Reserved

www.homeauto.com

CONTENTS

INTRODUCTION.....	5	INSTALLER SETUP.....	31
INSTALLATION.....	5	SETUP CONTROL.....	31
CONTROLLER HOOKUP	5	X-10 HOUSE CODE	31
ABOUT SECURITY ZONES	7	X-10 3-PHASE	31
BURGLAR ZONE HOOKUPS	7	OUTPUT TYPES.....	31
ABOUT FIRE ZONES	9	SETUP ZONES	32
TWO-WIRE SMOKE DETECTORS	9	WIRELESS RECEIVER.....	32
FOUR-WIRE SMOKE DETECTORS	9	ZONE RESISTORS	32
TELEPHONE CONNECTIONS	12	ZONE RESPONSE TIME	33
LCD CONSOLE HOOKUP.....	14	ZONE TYPES.....	33
CONSOLE SETUP.....	14	LATCHING ZONE TYPES	33
CONSOLE ADDRESS.....	14	DESCRIPTION OF ZONE TYPES.....	33
SOUNDER	14	SETUP DIGITAL COMMUNICATOR	36
KEY CLICK	14	FIRST PHONE NUMBER, FIRST ACCOUNT	
KEY BACKLIGHT	14	NUMBER	36
VIEWING ADJUSTMENT.....	14	SECOND PHONE NUMBER, SECOND ACCOUNT	
LANGUAGE	15	NUMBER	36
EXIT SETUP MODE	15	COMMUNICATOR TYPE	37
CONSOLE SELF TEST.....	15	TWO-WAY AUDIO.....	37
BELL OUTPUT	17	REPORT OPEN/CLOSE	37
CONTROLLER OUTPUTS	18	AUTOMATIC TEST TIME	37
GENERAL PURPOSE SWITCHING		ALARM CODES (4/2 and 3/1 Formats).....	37
APPLICATIONS	18	SETUP TEMPERATURES.....	38
SOUNDER TRIGGERING	18	TEMPERATURE DISPLAY	38
COMMUNICATOR OUTPUTS	18	THERMOSTAT TYPE.....	38
"ARMED" AND "OK TO ARM"	18	SETUP MISCELLANEOUS.....	39
SWITCHED OUTPUT	18	INSTALLER CODE	39
HOME CONTROL MODULES	18	ENABLE PC ACCESS	39
REMOTE ARM/DISARM SWITCH.....	19	PC ACCESS CODE.....	39
HAI THERMOSTATS.....	20	CALL BACK PHONE NUMBER.....	39
PROGRAMMABLE ENERGY SAVER MODULES ..	21	OUTSIDE SIREN DELAY	39
OUTDOOR TEMPERATURE, TEMPERATURE		DIAL OUT DELAY	40
SENSORS	22	ALARM RESET TIME	40
BUILT-IN SERIAL INTERFACE.....	24	ARMING CONFIRMATION.....	40
SYSTEM POWER UP PROCEDURE	25	FIRE ALARM VERIFICATION.....	40
CONSOLE CHECK OUT.....	25	SUPERVISE BELL	41
TELEPHONE CHECK OUT	25	ENABLE EMERGENCY KEYS.....	41
BURGLAR ZONE CHECK OUT	26	TIME DISPLAY	41
FIRE ZONE CHECK OUT	26	DATE DISPLAY	41
HOME CONTROL CHECKOUT	26	AC POWER FREQUENCY	41
CUSTOMER CHECKOUT	26	DEAD LINE DETECT	41
IN CASE OF TROUBLE	27	OFF HOOK DETECT	41
CONSOLES.....	27	PICKUP AFTER HANGUP	41
CONTROLLER.....	27	CLOCK ADJUSTMENT	42
X-10 TROUBLESHOOTING TIPS	28	MODEL AND SOFTWARE VERSION	42
DIGITAL COMMUNICATOR.....	29	RESET SYSTEM EEPROM.....	42
DESCRIPTION OF CONTACT ID.....	29	RESET SYSTEM RAM.....	42
DESCRIPTION OF 4/2 FORMAT	29	SETUP EXPANSION	42
3/1 FORMAT	30	MODULE 1 TYPE.....	42
OPENING AND CLOSING REPORTS	30	MODULE 2 TYPE - MODULE 4 TYPE	43
		SERIAL 1 RATE	43
		SERIAL 2 RATE	43
		OMNILT SPECIFICATIONS.....	44
		UNDERWRITER'S LABORATORIES (UL)	
		INSTALLATION REQUIREMENTS.....	45

**SMOKE DETECTOR INSTALLATION
GUIDELINES 46**

**APPENDIX A – CONTACT ID REPORTING
FORMAT 47**

FIGURES

FIGURE 1 – CONTROLLER HOOKUP6
FIGURE 2 - OVERALL CONNECTIONS DIAGRAM.....8
FIGURE 3 – TWO-WIRE FIRE ZONE CONNECTIONS.....10
FIGURE 4 – FOUR-WIRE FIRE ZONE CONNECTIONS11
FIGURE 5 - RJ31X JACK CONNECTIONS.....13
FIGURE 6 - CONSOLE CONNECTIONS.....16
FIGURE 7 - BELL CONNECTIONS17
FIGURE 8 - REMOTE KEYSWITCH CONNECTIONS19
FIGURE 9 - HAI THERMOSTAT CONNECTIONS20
FIGURE 10 - PESM CONNECTIONS23
FIGURE 11 - RS-232 CONNECTIONS.....24
FIGURE 12 - RS-485 CONNECTIONS.....24

INTRODUCTION

This installation guide is intended as an aid to installing the OmniLT automation system. The installer should also have thoroughly reviewed and understood the OmniLT Owner's Manual, which has important information regarding final setup of the system. This manual assumes that the installer has a basic understanding of installing a security system.

This guide applies to the Model 21A00 OmniLT controller. Refer to the Underwriters Laboratories Installation Requirements section for details in the application of each. Failure to install the OmniLT and its accessories in accordance with the UL Requirements in this manual and in the Owner's Manual, is a violation of the Listing Mark.

INSTALLATION

Go over your plan with your customer.

1. Install the entire system. Refer to sections in this manual to see how to install various components.
2. Follow the Power-Up and Checkout procedures.
3. Explain the basics to the customer. Deliver all manuals and documentation.
4. Follow up with your customer to keep them satisfied.

CONTROLLER HOOKUP

1. When choosing a place to mount the controller, consider the following:
 - a. A duplex outlet, preferably on its own circuit, is required to be within 5 feet of the controller for the power transformer and the X-10 Interface Module (if used).
 - b. The controller should be protected from weather, temperature extremes, and burglars.
2. **GROUND THE CONTROLLER "GND" TERMINAL TO A COLD WATER PIPE OR TO A 4-FOOT GROUND ROD TO PRESERVE ITS BUILT-IN TRANSIENT PROTECTION. USE 14 GAUGE WIRE. TRANSIENT PROTECTION WILL NOT WORK IF THE CONTROLLER IS NOT PROPERLY GROUNDED.**
3. Connect the 16.5 VAC power transformer to the 16 VAC INPUT terminals.
4. Connect the BLACK battery wire to the minus (-) terminal on the battery. DO NOT connect the red wire at this time. DO NOT reverse the connections; the battery fuse will blow. Note that the unit will NOT START on the battery alone.
5. If used, plug the X-10 Interface Module into the X-10 modular connector to the right of the PHONE connections. Use the supplied 4-conductor modular cable to connect the module to the jack on the processor board. The red LED on the interface module should be on and will blink off when the interface receives a signal from the controller.
6. Refer to **FIGURE 1 (CONTROLLER HOOKUP)** for this configuration.

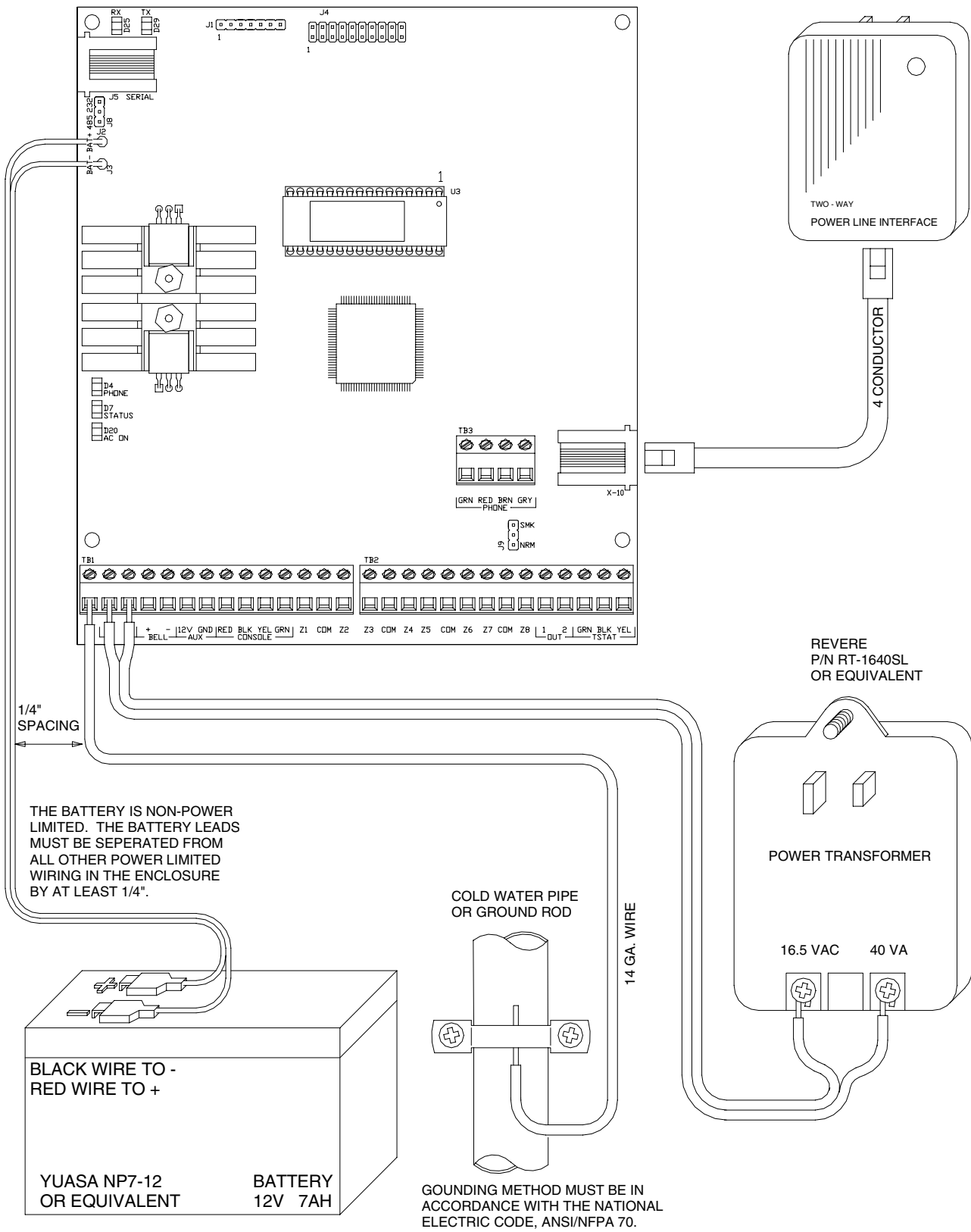

FIGURE 1 – CONTROLLER HOOKUP

ABOUT SECURITY ZONES

Zones 1-8 on the controller and zones 9-24 on the expander may be configured as security zones, fire zones, temperature zones, or auxiliary inputs. Zones 7 and 8 on the controller and zones 9-16 may also be configured as a PESM. Zone 8 is the only input that can be configured as a UL Supervised Fire Zone (required for UL installations). Any other zone may be configured as Fire Zone, however, it is not recognized by UL as a Supervised Fire Zone.

An external 1000-ohm end-of-line zone resistor is required for all zones unless the Setup item ZONE RESISTERS is set to "No". If the Setup item ZONE RESISTORS is disabled, all zones other than Supervised Fire and Gas will not use an end-of-line resistor. In this configuration, all zones switches (other than Supervised Fire and Gas) must be normally closed (open for alarm). If any zone requires a normally open (closed for alarm) switch (other than Supervised Fire and Gas), the Setup item ZONE RESISTORS must be set to "Yes" and all zones will require an external 1000-ohm end-of-line resistor.

The zone type for each zone is selected through the OmniLT SETUP menu on the console or by using the PC ACCESS software.

The system supports a maximum zone resistance, excluding the end-of-line resistor, of 150 ohms. The default setting for ZONE RESISTORS is "Yes". The default settings for all zone inputs on an OmniLT controller are configured as Auxiliary inputs.

BURGLAR ZONE HOOKUPS

The OmniLT system supports both normally open and normally closed switches. Most contacts designed for doors, windows, motion detectors, glassbreak detectors and other security devices meet this requirement. An external 1000-ohm end-of-line resistor must be used for all zones if ZONE RESISTORS is set to "Yes".

When ZONE RESISTORS are set to "No", only normally closed switches can be used.

1. When using a normally open switch, a 1000-ohm end-of-line resistor must be in parallel with the zone being used. Maximum loop resistance excluding end-of-line resistor should not exceed 150 ohms. ZONE RESISTORS must be set to "Yes".
2. When using a normally closed switch, a 1000-ohm end-of-line resistor must be put in series with the zone being used if ZONE RESISTORS are set to "Yes". If ZONE RESISTORS are set to "No", the 1000-ohm end-of-line resistor is not used. Maximum loop resistance excluding end-of-line resistor should not exceed 150 ohms.
3. Power motion detectors from AUX 12V.
4. Unused zones may be left open, and should be left at the default setting of AUXILIARY zone types.
5. When Zone 8 is configured to anything other than a Supervised Fire or Gas zone, the Zone 8 Jumper (J9) should be set to the NRM (normal) position.
6. See **FIGURE 2 (OVERALL CONNECTIONS DIAGRAM)** for configurations of burglary zones.

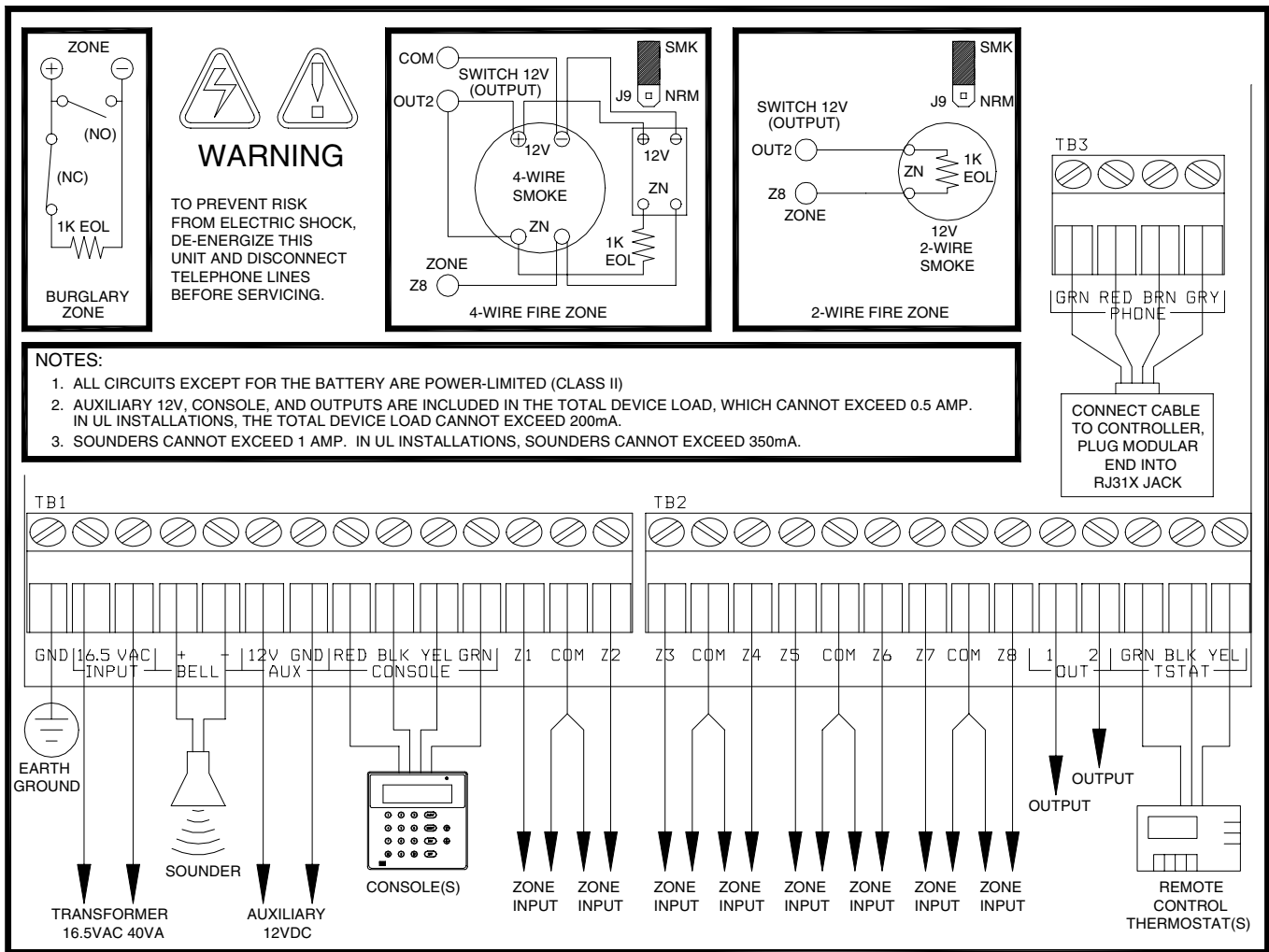

FIGURE 2 - OVERALL CONNECTIONS DIAGRAM

ABOUT FIRE ZONES

The OmniLT system supports normally open (closed for alarm), two-wire or four-wire smoke detectors. Two-wire smoke detectors can only be connected to Zone 8. Four-wire smoke detectors can be connected to any zone (1-8). An external 1000-ohm end-of-line resistor must be used for all fire (and gas) zones. When Zone 8 is used as a Supervised Fire (two-wire or four-wire) or Gas zone, the Zone 8 Jumper (J9) must be in the "SMK" (smoke) position.

1. Smoke detectors must be powered from an Output configured as a SWITCHED POWER OUTPUT.
2. End of line resistor: 1000 ohms. Maximum loop resistance EXCLUDING end of line resistor is a 150 ohms. Use HAI Model 1503A0011 End of Line Resistor Assembly in UL Listed Installations.
3. Smoke detectors are reset when the security system is armed.

TWO-WIRE SMOKE DETECTORS

OmniLT supports two-wire smoke detectors connected to Zone 8.

1. Use normally open (closed for alarm) two-wire "SYSTEM" type smoke detectors (System Sensor 2100TS or equivalent), rated 8 - 14 VDC.
2. Smoke detectors must be connected to Zone 8 and configured as a Supervised Fire Zone.
3. An external 1000-ohm end-of-line resistor must be used.
4. Connect to the SWITCHED POWER OUTPUT as shown.
5. The Zone 8 Jumper (J9) must be in the SMK (smoke) position.
4. Refer to **FIGURE 3 (TWO-WIRE FIRE ZONE CONNECTIONS)** for this configuration.

FOUR-WIRE SMOKE DETECTORS

OmniLT supports four-wire smoke detectors connected to any zone (1-8).

1. Use normally open (closed for alarm) four-wire "SYSTEM" type smoke detectors (System Sensor 2112/24TR or equivalent), rated 8 - 14 VDC.
2. An End of Line Power Supervision Relay Module (System Sensor A77-716B or equivalent) is required for UL installations. Install 1000-ohm end-of-line resistor as shown.
3. Power the smoke detector from the SWITCHED POWER OUTPUT as shown.
4. When connected to Zone 8, the Jumper (J9) must be in the SMK (smoke) position.
5. Refer to **FIGURE 4 (FOUR-WIRE FIRE ZONE CONNECTIONS)** for this configuration.

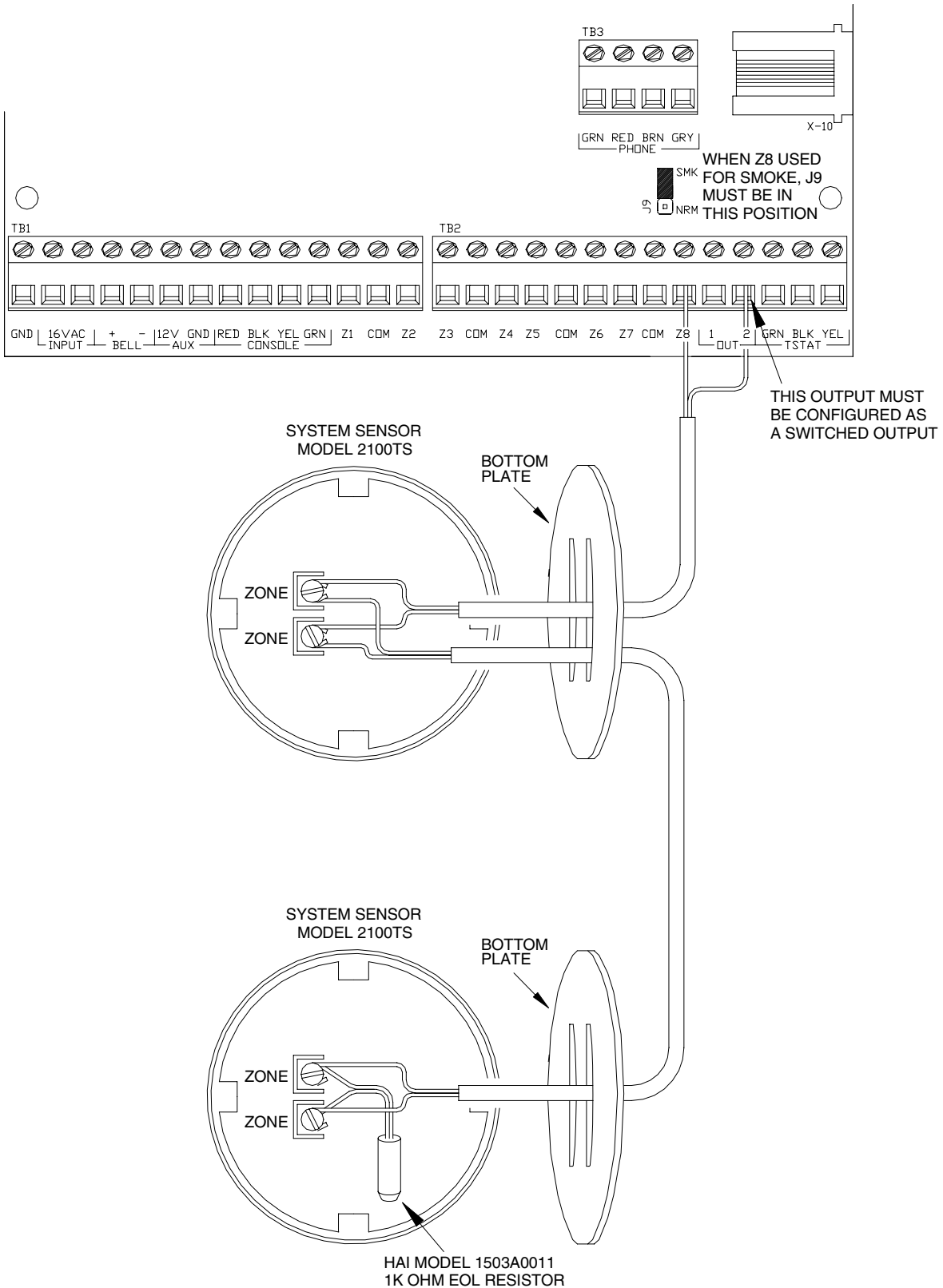

FIGURE 3 – TWO-WIRE FIRE ZONE CONNECTIONS

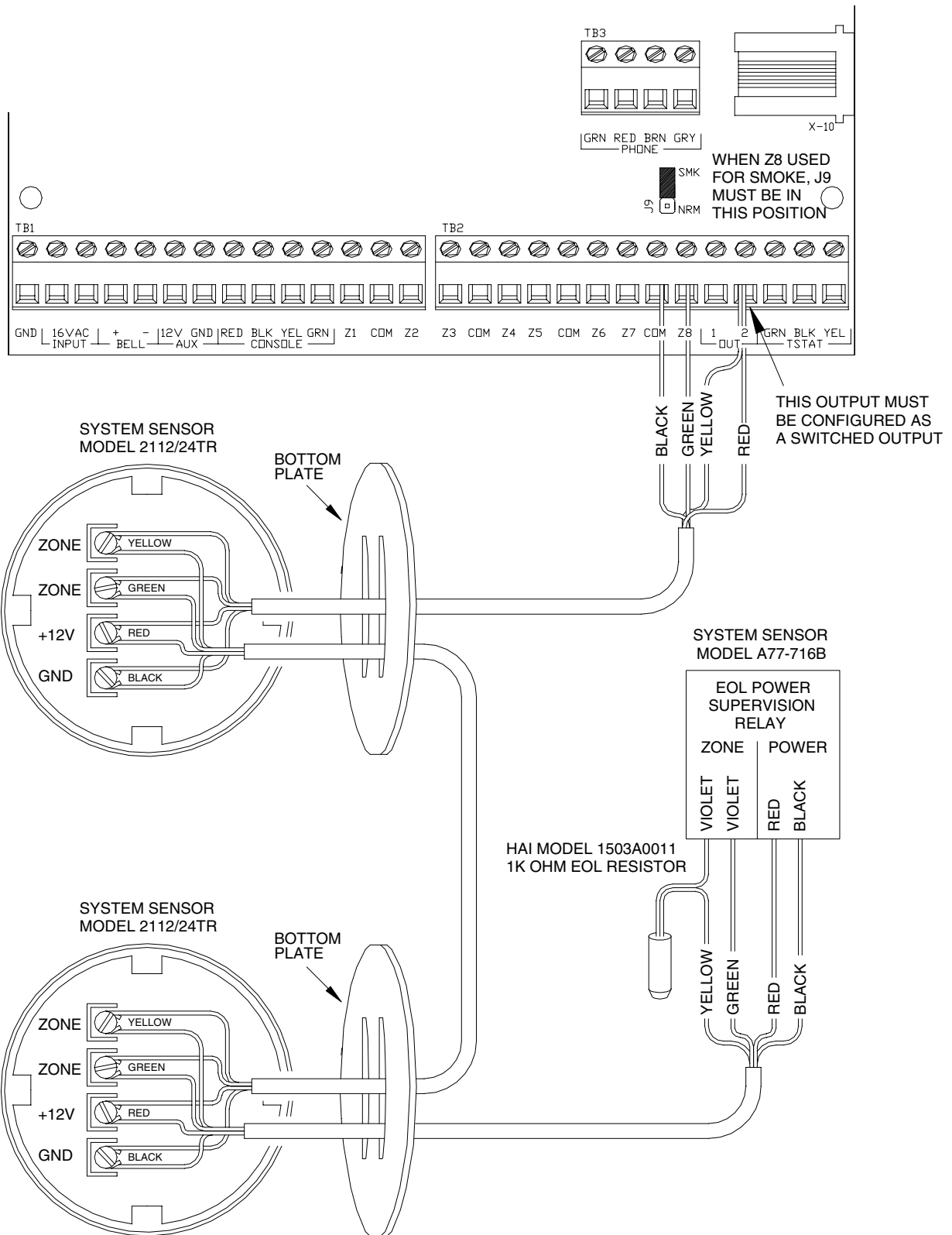

FIGURE 4 – FOUR-WIRE FIRE ZONE CONNECTIONS

TELEPHONE CONNECTIONS

1. If an RJ31X jack has been supplied by the telephone company, it is probably wired correctly and the controller can be connected by plugging the supplied 8 conductor telephone cable into the RJ31X jack. The other end of the cable is spaded (remove the spade connectors from the wires used). The green, red, brown, and gray wires must be connected to the controller at the designated terminals under the section of the board marked 'PHONE'.
2. If required, install the supplied RJ31X jack as shown in the following diagram. The polarity must be correct for proper operation of the phone access feature.
3. IT IS IMPERATIVE THAT THE PHONE LINE COMING INTO THE HOUSE BE CONNECTED TO A GROUNDED SURGE ARRESTOR OUTSIDE THE PREMISES. IT IS THE RESPONSIBILITY OF THE TELEPHONE COMPANY TO PROVIDE THIS SURGE ARRESTOR.
4. INSPECT THE INCOMING PHONE LINES. THE FIRST THING THAT THEY SHOULD GO TO IS A SMALL BOX ON THE OUTSIDE OF THE PREMISES. THERE SHOULD BE A HEAVY GROUND WIRE COMING FROM THIS BOX GOING TO A COLD WATER PIPE OR A SEPARATE GROUNDING ROD.
5. IF THERE IS NO SURGE ARRESTOR OR IF THE GROUND WIRE IS MISSING, HAVE THE CUSTOMER INSIST THAT THE TELEPHONE COMPANY INSTALL ONE FOR THE SAFETY OF THE CUSTOMER.
6. WHEN WIRING A RJ31X JACK, MAKE SURE THAT THE INCOMING PHONE LINES GO TO THE TELEPHONE COMPANY SURGE ARRESTOR BEFORE THEY GO TO THE RJ31X JACK.
7. When the RJ31X is installed as shown, locate the green, red, brown, and gray wires from the 8 conductor phone cable and connect to the section on the OmniLT controller marked 'PHONE'. Plug the modular end of the cable into the RJ31X jack. If necessary, bend the tab up on the plug to ensure a tight fit that will not fall out.
8. Verify the following if you have trouble during check out: With the system running, the RJ31X jack properly connected and all phones on-hook (hung up), the PHONE LED, located on the left side of the controller, should be OFF. If it is on, reverse the RED and GREEN wires to both the house phones and the telephone company wires at the RJ31X jack. When the receiver is picked up on any phone, the PHONE LED will come on. When the phone line rings, the PHONE LED will light.
9. If the OmniLT is accessed on an in house telephone, the OmniLT will disconnect the phones from the phone company lines and supply its own talk voltage to the phones. The PHONE LED will be on in this case.
10. Refer to **FIGURE 5 (RJ31X JACK CONNECTIONS)** for this configuration.

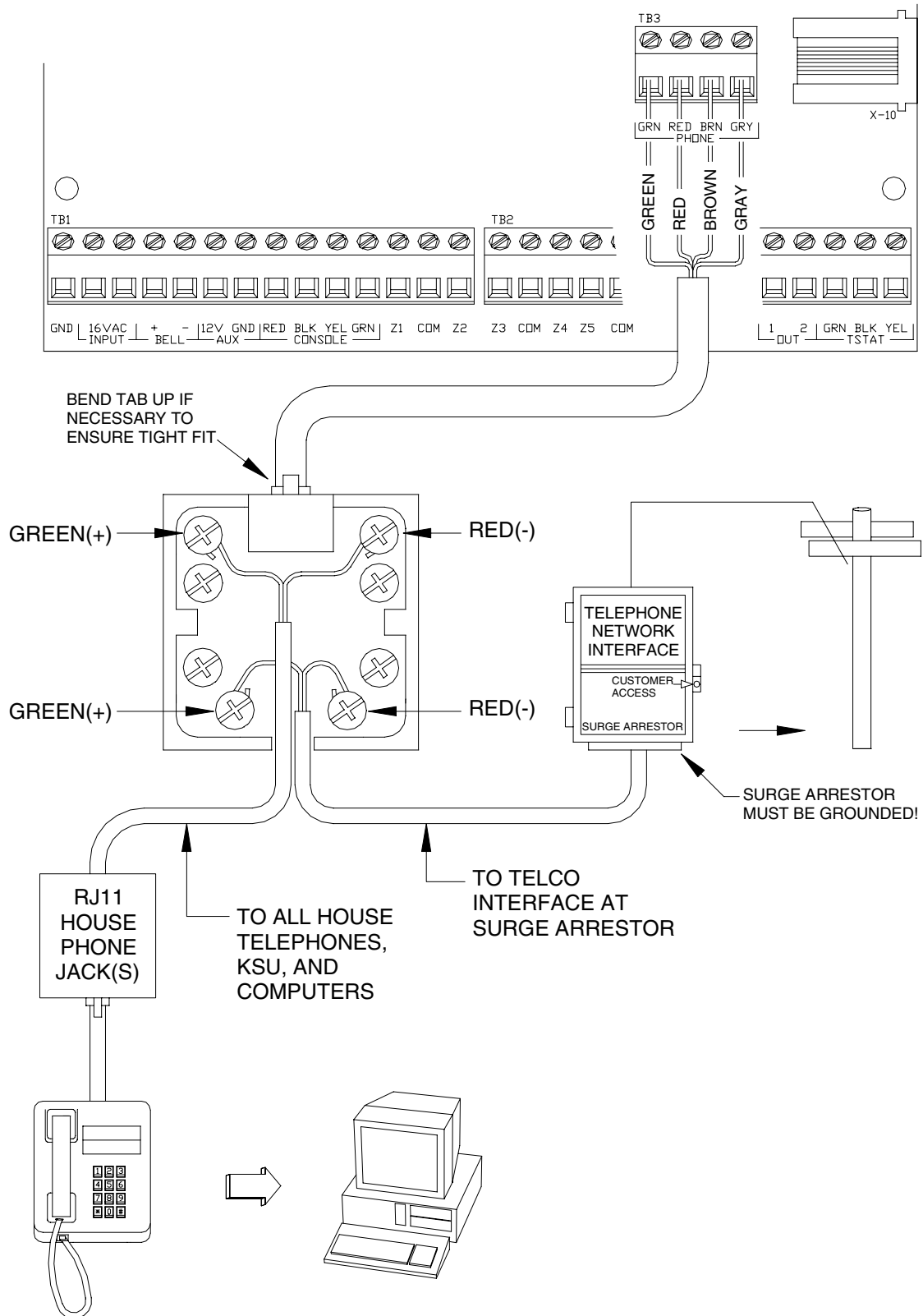

FIGURE 5 - RJ31X JACK CONNECTIONS

LCD CONSOLE HOOKUP

1. 4 LCD Consoles (Models 11A00-1, 11A00-2, 11A00-9, and 15A00) **MAXIMUM** per system, subject to power availability.
2. Use 4-conductor 22-gage wire, 1000 feet maximum length. Consoles can be homerun or daisy chained. This length shall be divided by the total number of consoles at the end of the run. For example, for 4 consoles, the maximum length reduces to 250 feet. All LCD Consoles are connected to the same 4 wires, RED (+12), BLK (Ground), YEL (A), GRN (B).
3. The console should be mounted so that the LCD display is at or slightly above eye level. Consoles should be kept out of the reach of young children. A good height is approximately 58 inches from the floor to the bottom of the console enclosure.
4. Remove console face from back plate (slots on bottom of console will release back plate, use a screwdriver). Mount the back plate to the wall. Mounting holes are designed to fit on a single or double gang box, or directly to the wall. Pull the wires from the wall through the opening in the back plate. Splice the wires to the supplied cable. Connect the cable to the connector on the console board (J1). Snap the console face on to the back plate. Remove protective film from the LCD lens.
5. Refer to **FIGURE 6 (CONSOLE CONNECTIONS)** for this configuration.

CONSOLE SETUP

The console has different operating options that can be setup from the console to the user's preference. If more than one console is being used, it is required that you give each console a different address. You can change the address of a console through the console setup mode.

To enter the console setup mode, simultaneously press and hold the 4 and up arrow (↑) for approximately 1 second. The console will beep 5 times and enter the setup mode. The top line of the display will indicate what you are doing, followed by the current setting. The bottom line will show a menu of your options. To the lower right corner of the display is the direction arrow(s). Where possible, the up (↑), down (↓), and two-headed (↕) arrow characters are shown on the console display to indicate which arrow keys may be pressed at that time. Press the down arrow (↓) key to advance to the next item. Press the up arrow (↑) key to go back to the previous item.

CONSOLE ADDRESS

If you are installing more than one console, each console must be set to a different address. The default address setting is (1) - this is adequate if only one console is being used. The choices at the bottom are 1-16; however, the OmniLT only supports 4 consoles. When making your choice, choose an address between 1-4, then press the # (pound) key.

SOUNDER

If you wish not to hear the beeper in the console for any reason, the sounder option can be turned off. Select (0) for OFF or (1) for ON, then press the # key.

KEY CLICK

The sounder makes a click every time a key is pressed. This option may also be turned off. Select (0) for OFF or (1) for ON, then press the # key.

KEY BACKLIGHT

The keys on the console keypad are lit. The keys can be never lit, always lit, or only lit when the LCD display is lit. Select (0) OFF, (1) for ON, or (2) TIMED, then press the # key.

VIEWING ADJUSTMENT

This option is an adjustment for the viewing angle of the LCD display. This has been set to its best value at the factory, however, you may wish to tweak it. The display has 20 levels of adjustment. Select (1) for a lower viewing angle, or (2) for a higher viewing angle.

LANGUAGE

This option is to display the 'console setup' text on the LCD display in English, French, Italian, or Spanish. Select one of the languages, then press the # key.

EXIT SETUP MODE

To exit Setup Mode, press and hold the 4 and up arrow (↑) keys simultaneously for about 1 second. The console will return to normal operation. You may need to press (*) to restore the display.

CONSOLE SELF TEST

Use the self test mode to verify the proper operation of the console.

1. Disconnect the console from the controller. Connect the RED (+12) and BLACK (Ground) wires to a 12-volt source (or a fresh 9-volt transistor battery). The console beeper will beep twice per second, the LCD backlight and the keypad key will be lit, and the LCD will display "NO CONTROLLER DATA".
2. Simultaneously press and hold the 7 and the down arrow (↓) keys for approximately 3 seconds. The beeper will beep 5 times, the LCD backlight and keypad backlight will turn off, and the display will clear. The LED at the top right corner of the console will start to cycle through its different colors (red, green, yellow, then turns off). At the end of each cycle the beeper will beep once.
3. Press any key. The LCD backlight and the keypad key backlight will turn on.
4. Press the keys in the following order and verify that the appropriate character fills the screen. 0 - 9, *, #, AWAY (A), NIGHT (B), DAY (C), OFF (D), ↑ (filled blocks), and ↓ (blanks).
5. If this is successful, the console is good. Simultaneously press and hold the 7 and down arrow (↓) keys to exit the self test mode or disconnect power.

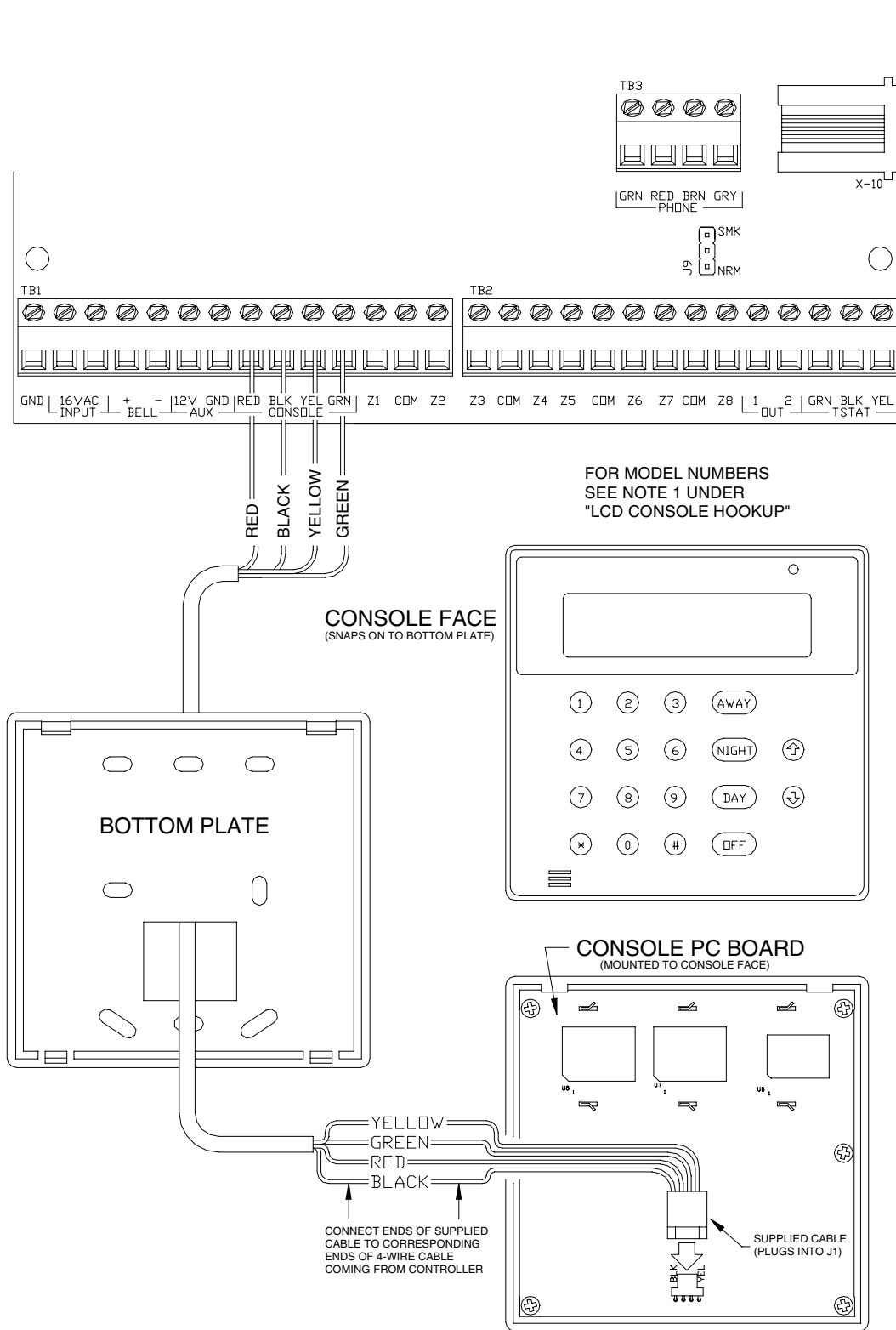

FIGURE 6 - CONSOLE CONNECTIONS

BELL OUTPUT

The Bell Output provides 12VDC to power bells, piezo sirens, self-contained sirens, and siren drivers (do not connect speakers to the Bell Output). Sounders can draw up to 1 amp **MAXIMUM** - (See Specifications for UL Ratings).

1. Locate interior sounders in a central location. The sounder is very loud. Do not install it in a room where small children or animals could be trapped if the alarm is activated. Note that the Bell Output defaults to an Interior Sounder Output Type.
2. The Bell Output monitors the wiring to bells and sirens. It will report trouble if an open, short, or other wiring problem is detected in the supervised bell circuit. It will also make a digital dial out when violated.
3. For UL Listed residential fire alarm applications, the UL Listed Wheelock Model MT-12/24-R Multitone Signal or equivalent must be used, and the "SUPERVISE BELL" feature must be set to "ON".
4. Refer to **FIGURE 7 (BELL CONNECTION)** for connections.

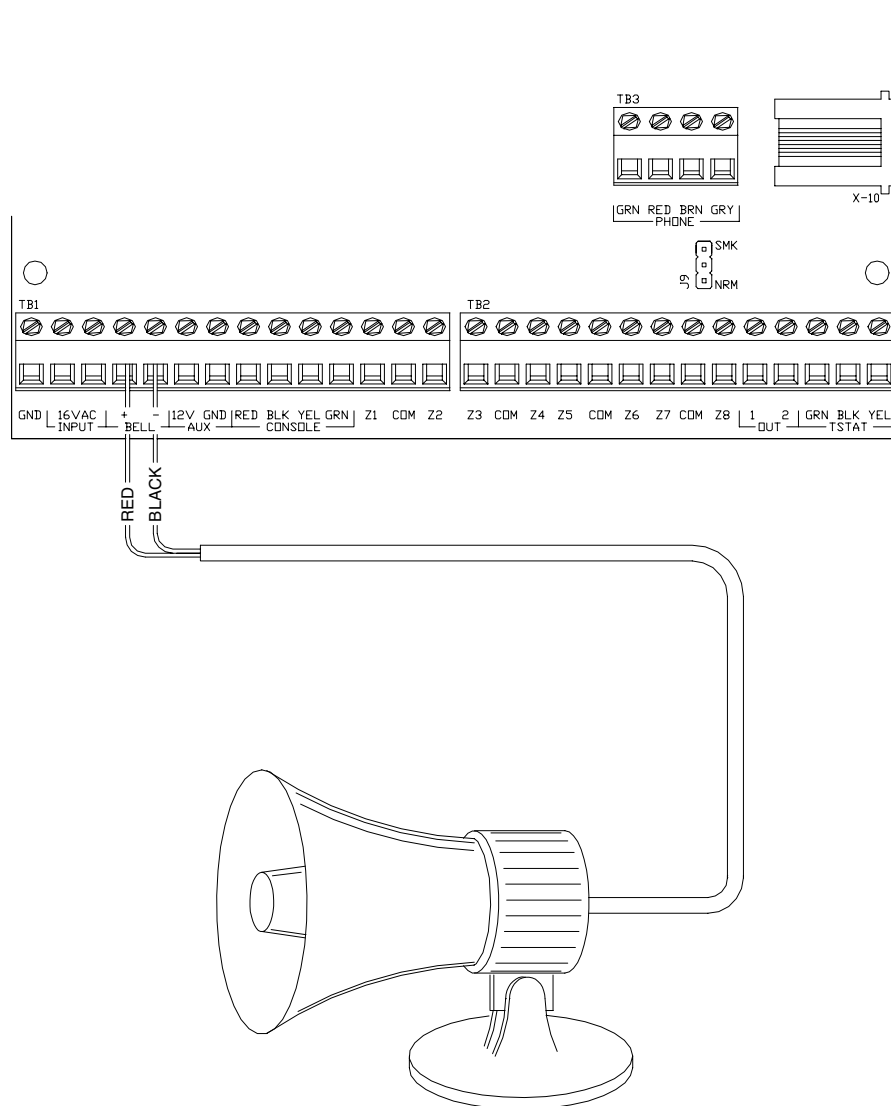

FIGURE 7 - BELL CONNECTIONS

CONTROLLER OUTPUTS

The OmniLT provides 2 programmable hardwired voltage outputs on the controller and 8 voltage outputs on the Expansion Module. These outputs are programmable for the following output types:

- General Purpose low voltage switching applications (12 VDC)
- Sounder triggering (interior and exterior sounders and voice drivers for BURG and FIRE)
- Communicator outputs (radio, cellular, or any other type of auxiliary communicator)
- 'ARMED' and 'OK TO ARM' outputs
- Switched Output (to power smoke detectors and cycle power to latching devices)

Outputs 1 and 2 can supply a **maximum** of 100 mA total.

GENERAL PURPOSE SWITCHING APPLICATIONS

This output will supply 12 VDC to the output terminal when its corresponding unit is ON.

SOUNDER TRIGGERING

This output can be used as a trigger for siren and voice drivers. When a driver requires a separate input for burglary and fire, you can configure this output to give a voltage trigger to the driver.

COMMUNICATOR OUTPUTS

This output can be used for radio communications or any other type of auxiliary communications to augment the built-in digital and voice dialers. Any communications device can be used with the OmniLT, provided that it is powered by 12 VDC, has 12 VDC triggered inputs, and has 2 (or more) channels.

The 'Communicator' outputs are activated 3 seconds before the OmniLT dialer begins to dial, either using its built-in digital dialer or voice dialer.

The following events will activate the BURG output: Burglar alarms (including panic zones), Auxiliary emergencies, Police emergencies, and Duress alarms. Fire alarms and the fire emergencies will activate the FIRE output.

"ARMED" AND "OK TO ARM"

ARMED: When the system is armed in any of the security modes (AWAY, NIGHT, or DAY), this output will be active. It is typically used to activate a red LED to indicate that the system is 'armed'.

OK TO ARM: When all security zones are secure, no zones are bypassed, and the system is in the 'OFF' mode, this output will be active. It is typically used to activate a green LED to indicate that the system is 'ok to arm'.

SWITCHED OUTPUT

This output is used to cycle power to latching devices when the system is armed. Use this output whenever smoke detectors are connected to the system. This output will reset the smoke detectors when the system is armed after an alarm.

HOME CONTROL MODULES

If used, install X-10 or compatible modules EXACTLY as described in the instructions that come with each module. Watch the load ratings and types of load allowed. The OmniLT is designed to send signals to any device compatible with the X-10 power line carrier protocol

REMOTE ARM/DISARM SWITCH

1. If desired, a remote keyswitch, keypad, or hidden arm/disarm toggle can be connected to the system. The device should have a momentary close type switch.
2. Configure one of the zone inputs as a KEYSWITCH zone. A closure of the switch contacts will toggle the arming mode between OFF and AWAY (Entry and Exit delays are still active).
3. Configure one of the outputs as an "ARMED" and another output as an "OK TO ARM" output. These outputs are used to activate a red and a green LED based on the state of the alarm system. The "ARMED" and "OK TO ARM" outputs can supply a **maximum** of 100 mA each. These outputs are included in the total DEVICES load, which cannot exceed 500 mA.

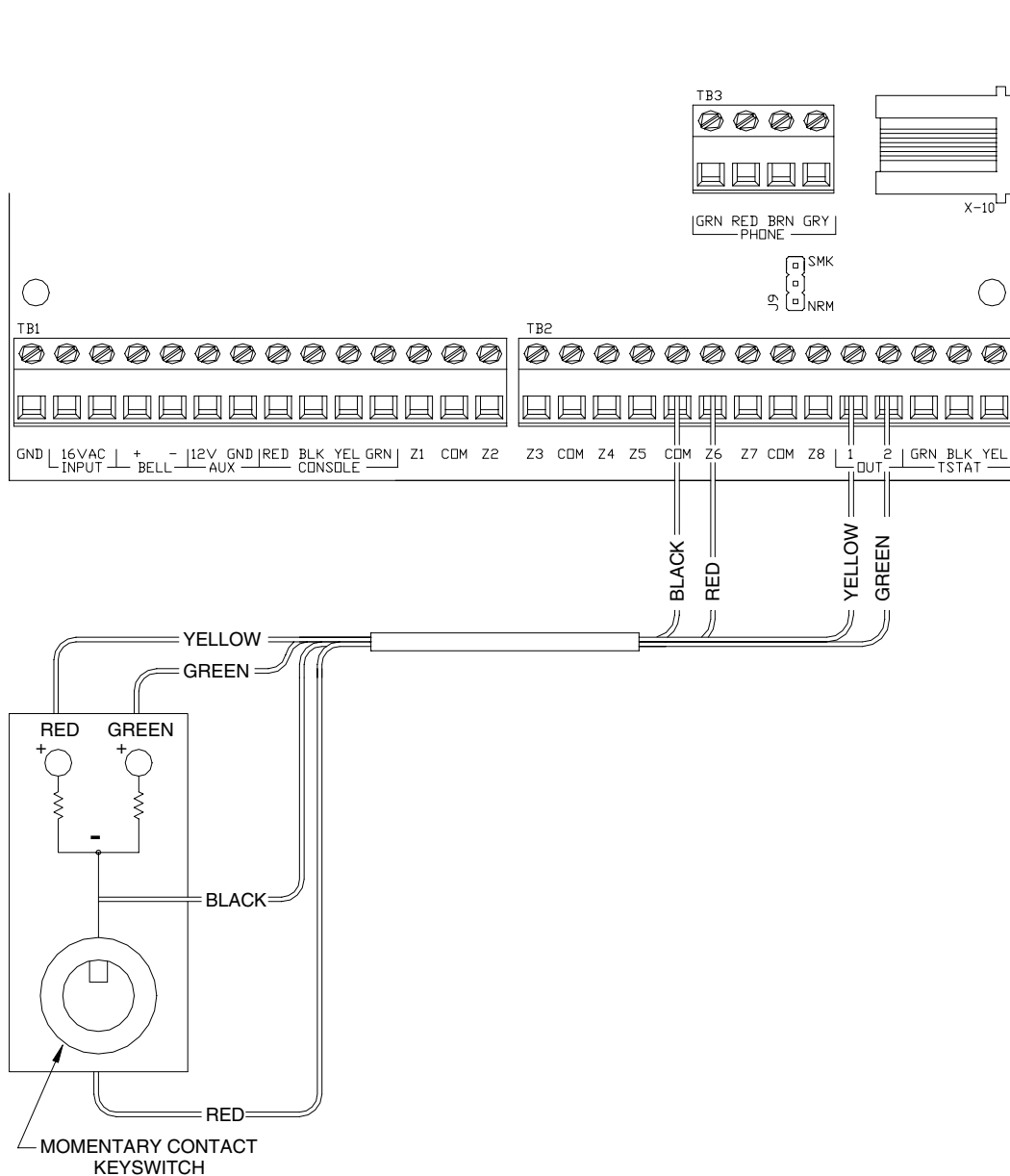

FIGURE 8 - REMOTE KEYSWITCH CONNECTIONS

HAI THERMOSTATS

OmniLT supports up to 2 HAI RC-Series Communicating Thermostats. The controller can send commands to the thermostat to change mode, cool setting, heat setting, status of fan and hold, and other items.

Run a 3 (or 4) conductor wire from OmniLT to the thermostat location. All thermostats are connected to the GRN (Green), BLK (Black), and YEL (Yellow) terminals in the section marked "TSTAT" on the OmniLT controller. Connect the red COMM cable wire with the black COMM cable wire. Make the connections (as shown in Figure 9) using the supplied wire splices.

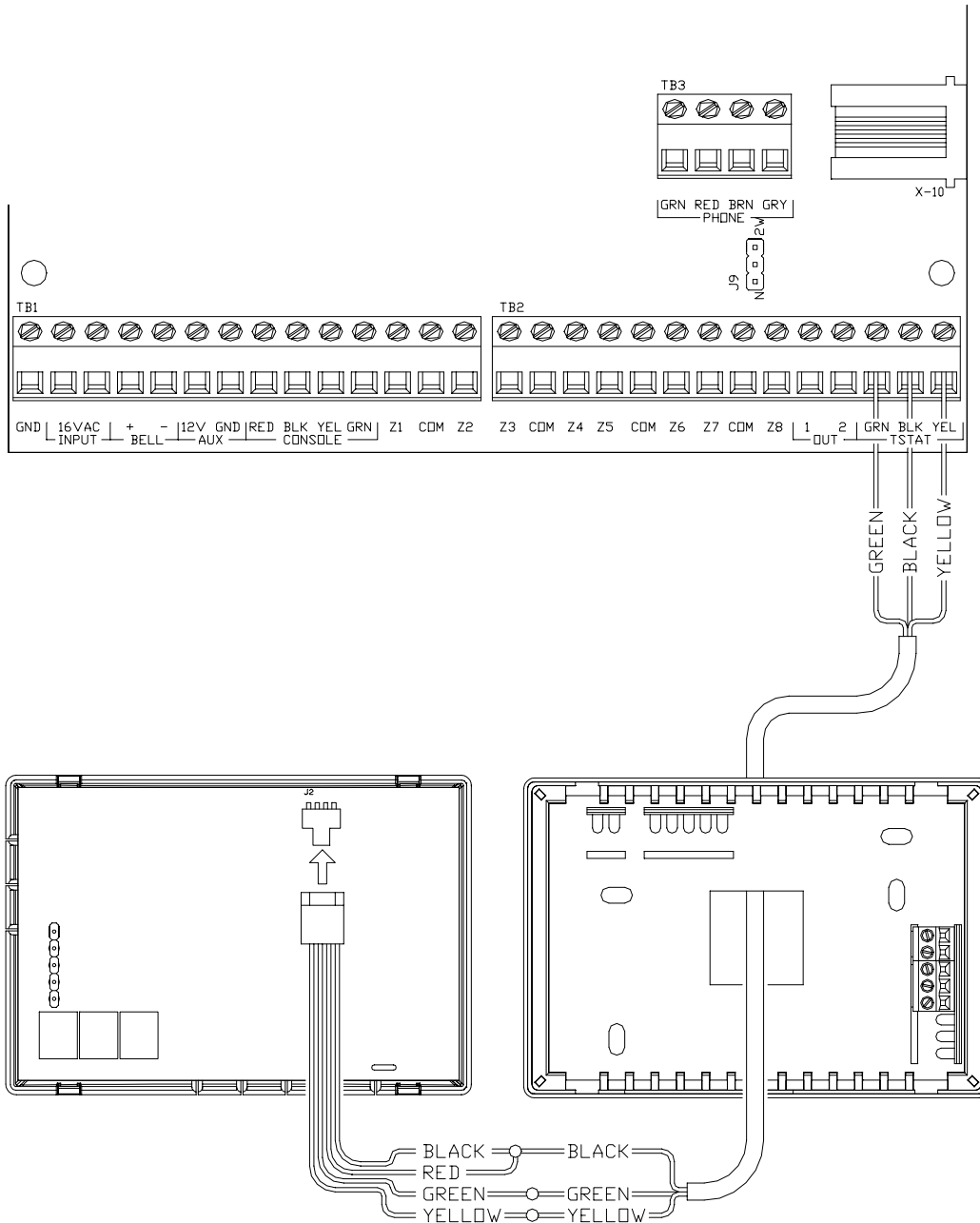

FIGURE 9 - HAI THERMOSTAT CONNECTIONS

PROGRAMMABLE ENERGY SAVER MODULES

Programmable Energy Saver Modules may be connected to:

Controller: Zone 7 and Output 1 and/or Zone 8 and Output 2
Expansion Module: Zone 1 and Output 1 through Zone 8 and Output 8, respectively

Note: Zones labeled 1-16 on the Expansion Module correspond to Zones 9-24.

1. The OmniLT can support up to 10 Programmable Energy Saver Modules (2 on the controller and 8 on the expander). Each PESM requires one security zone input and one output. The PESM zone inputs corresponds to controller outputs. When configured as a PESM Zone Type (Type 80), the zone and unit is used as a pair to read temperature and control the setback temperature of the house.
2. Run a 4-conductor wire from the OmniLT controller to each PESM. Connect as shown in FIGURE 9.
3. The PESM should be mounted on an interior wall, preferably close to the HVAC thermostat. Run a 2-conductor wire from the PESM to the thermostat. Connect the PESM between the RED wire going to the thermostat and the RED terminal on the thermostat.
4. Program the zone type for PESMs as a Type 80, Energy Saver. It may also be programmed as a Temperature (Type 82), or Temperature Alarm (Type 83) for special applications.

NOTES ON HVAC SYSTEMS

1. Description of the PESM

The PESM is a temperature sensor and control relay in a small enclosure that mounts near a central heating, ventilation, and air conditioning (HVAC) system thermostat. The PESM allows the automation system to read the temperature of the area that the HVAC system controls. The relay in the PESM is used to break the 24V RED wire between the thermostat and the HVAC system. When the automation system is in setback mode and the actual temperature is between the LO and HI setpoints, the relay energizes to break the 24V red wire; hence, the HVAC system will no longer operate.

In heating season, when the actual temperature falls below the LOW setpoint, the automation system turns the relay in the PESM off, thus restoring power to the thermostat, allowing the thermostat to heat as it normally would under the control of the thermostat. The PESM will cycle the thermostat on and off to maintain the LOW setpoint.

In cooling season, when the actual temperature rises above the HI setpoint, the automation system turns the relay in the PESM off and the thermostat will cool as it normally would under the control of the thermostat. The PESM will cycle the thermostat on and off to maintain the HI setpoint.

The Red LED on the PESM will illuminate when the PESM is overriding the thermostat. The Red LED will be off when the thermostat is working normally.

If the PESM is disconnected from the automation system, the relay will not energize and the HVAC system will operate normally, under the control of the thermostat.

2. Standard Heating and Cooling Systems

The PESM is compatible with all mechanical thermostats. Recommended thermostats are simple, round Honeywell T-87 thermostats. For automatic switch-over from heat to cool, consider a Honeywell T-874 (mechanical) or an Enerstat DSL-300 (electronic) thermostat, although any other mechanical thermostat from White Rodgers, Robertshaw, etc. will work.

3. The PESM is also compatible with electronic thermostats that run totally on battery power. Some examples of battery powered thermostats are Maple Chase Saverstat (Mfg. #0960-1), White-Rodgers Digital Programmable Thermostat (Mfg. #1F80-51), and Honeywell Chronotherm Thermostat.

4. Heat Pumps

Programmable Energy Saver Modules are compatible with heat pumps, however, the savings gained by setting the heat pump back may be erased by the auxiliary heaters when the heat pump tries to recover from the setback. A PESM will work best with heat pumps that have one or more of the following features:

- a. An outdoor temperature switch that prevents the auxiliary heat from coming on unless it is very cold outside. This is sometimes called a "heat balance" switch.
- b. A thermostat that uses rate of rise to determine if auxiliary heat is necessary: The Enerstat Model DSL-450. When recovering from setback, the thermostat runs the heat pump first. It will run the auxiliary heat only if the rate of temperature rise is less than 6 degrees F. per hour.
- c. An alternative auxiliary heat source that is inexpensive (i.e. gas).

These features will avoid the use of auxiliary heat (usually an electric strip heater) which is more expensive than using the heat pump when recovering from setback. In general, heat pumps take a longer time to recover from setback, so it may be advantageous to program a setback only for extended periods, such as a vacation.

OUTDOOR TEMPERATURE, TEMPERATURE SENSORS

The Model 14A00 is a temperature sensor that can mount in an outdoor location, usually under an overhang, and sends the outdoor temperature to an OmniLT system. It is coated with a sealant to withstand outdoor moisture. The outdoor temperature can be displayed on the console, spoken over the telephone, or displayed on an HAI communicating thermostat.

1. Each Model 14A00 Temperature Sensor requires one zone input.
 - Program the zone type as an Outdoor Temperature (Type 81). It may also be programmed as a Temperature (Type 82), or Temperature Alarm (Type 83).
2. Plan to mount the Model 14A00 under an overhang or to the underside of an eave, otherwise known as the soffit, to protect it from direct sunlight and rain. Run a 4-conductor wire from the HAI controller to the selected location.
3. Connect the red conductor to AUX 12V, the black conductor to AUX GND, and yellow conductor to the Zone (Z1-Z24) using the 3 B-GEL watertight wire splices. The green conductor is not used.
4. Mount the 14A00 using the 2 - #6 x 1/2" stainless steel self-tapping screws.

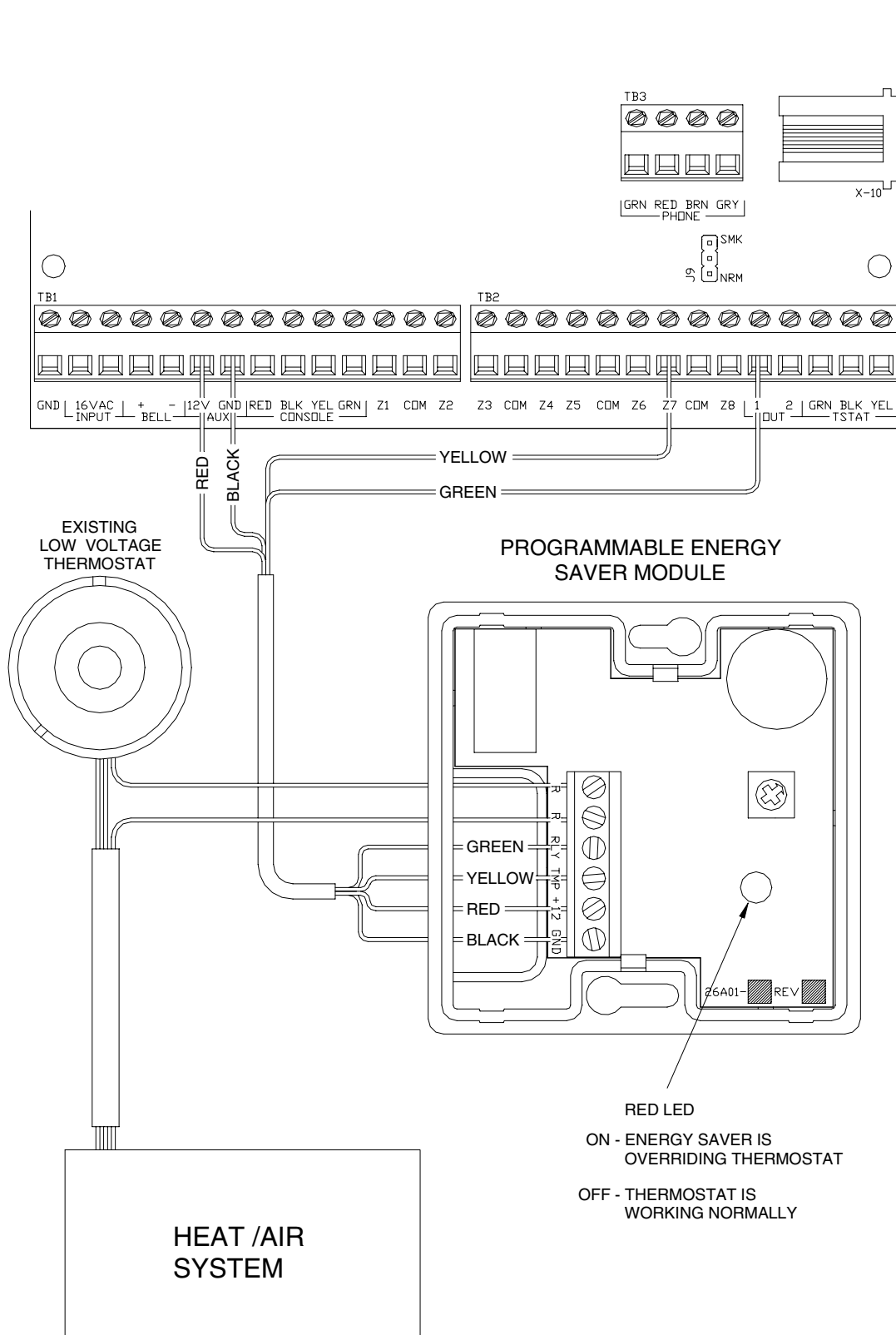

FIGURE 10 - PESM CONNECTIONS

BUILT-IN SERIAL INTERFACE

OmniLT has a serial interface built onto the controller (designated as J5 SERIAL). The interface is a modular connector located in the upper left corner of the controller. It uses the Omni-Link Protocol for connections to the Internet via HAI Web-Link, personal computers, and other optional interfaces like touchscreens, voice recognition, and home theater controls.

The serial interface supports both RS-232 and RS-485 connections. RS-232 is the standard for connections to most personal computers and related systems. RS-485 can support greater wiring distances. The default setting is RS-232. To select RS-485, move the (J8) interface jumper (below the J5 SERIAL modular connector) from the 232 to the 485 position.

To access the serial interface, use the HAI Model 21A05-2 OmniLT Serial Cable Kit. Plug one end of the cable into the "J5 Serial" modular connector on the OmniLT controller. Plug the other end into the Model 21A05-1 Communication Cable Adaptor (modular to DB-9 RS-232), which connects the OmniLT serial port to computer DB-9 RS-232 port.

To make you own serial cable, follow the diagrams below. When making connections, be sure to correctly orient the cable as shown (with the tab on the modular cable facing up, make sure that the Yellow wire is at the top). Connect the Yellow, Green, Red, and Black wires to the DB-9 connector as shown. Also, connect Pins 1, 4, and 6 together and Pins 7 and 8 together.

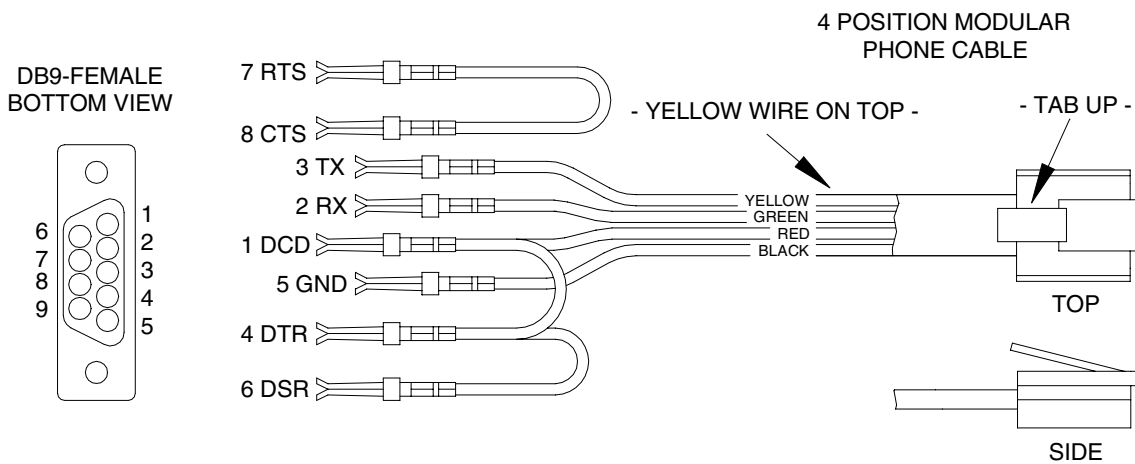

FIGURE 11 - RS-232 CONNECTIONS

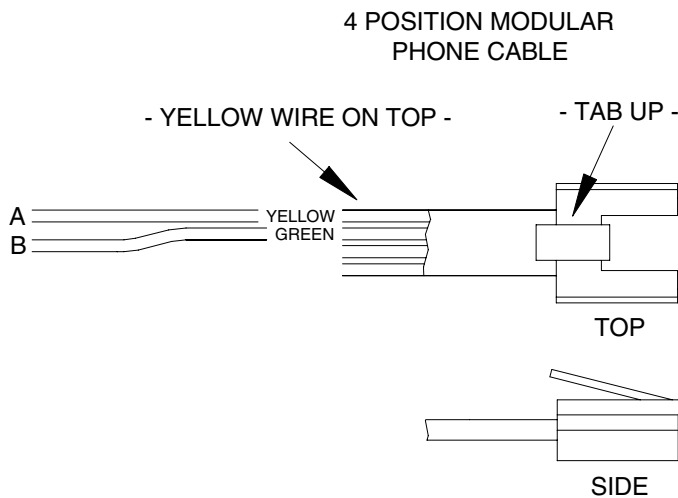

FIGURE 12 - RS-485 CONNECTIONS

SYSTEM POWER UP PROCEDURE

1. Carefully review connections to the zones, grounds, sounders, and consoles.
2. Disconnect the sounders.
3. The positive lead to the battery should be disconnected. Make sure that the red battery wire is not touching anything.
4. Plug in the power transformer (**transformer must be 16.5VAC**):
 - The AC ON LED should illuminate.
 - The STATUS LED should begin blinking at a rate of 1 blink per second. This indicates that the OmniLT processor and software are working.
 - The PHONE LINE LED should be OFF (if all telephones are on hook and the RJ31X jack is properly connected).
5. Unplug the power transformer to kill the system. Connect the red battery wire to the + (positive) battery terminal. The system should not start.
6. Plug in the transformer. The system should start.
7. Unplug the transformer. The system should continue to run on the battery (as evidenced by the flashing STATUS LED)
8. Plug the transformer back in and secure it to the outlet.

CONSOLE CHECK OUT

1. The console(s) should be operating. Press '*' to silence the trouble beeper if it is beeping. Press OFF, 1, 1, 1, 1 (or the current code) if the alarm is tripped. If the consoles are not operating properly, make sure that consoles do not have the same address, and check the wiring.
2. With all doors and windows closed and all motion detectors normal, the bottom line of the display should read SYSTEM OK. If there are any trouble indications that occurred during installation, press '*' to acknowledge them and silence the beeper.
3. Set the time and date by pressing 9, enter the Master Code, then the 2 key. Enter the time on the keypad, then the DATE (enter date as 6 characters: January 1, 00 as 010100).
4. The console should now show the time and date on the top line, "SYSTEM OK" on the bottom line.

TELEPHONE CHECK OUT

1. Verify that the Telephone Company surge arrestor is properly grounded.
2. Verify that the incoming telephone lines are run to the surge arrestor first, then from the surge arrestor to the RJ31X jack, then from the RJ31X jack to the house phones.
3. The PHONE LINE LED, on the controller, should be off when the phones are hung up.
4. Pick up an in-house phone, wait about 1 second, then press the '#' key. You should hear the voice menu on the phone. If not, check to see that the RJ31X jack is properly wired and connected to the controller. There should be no interference from the Telephone Company while the menu is being read over the phone.

5. Record the owner's NAME and ADDRESS in the ADDRESS speech memory as shown in SETUP ADDRESS in the OWNER'S MANUAL (Press 8, 9, then 1111 or the current Master code to record the address).

NOTE: DO NOT record any TOUCH TONES in the ADDRESS!

6. Check that all in-house phones are working.

BURGLAR ZONE CHECK OUT

1. With all doors and windows closed and all motion detectors and security devices normal, you should have "SYSTEM OK" on the console.
2. If any zones are abnormal, check your wiring. If the battery indication is low, make sure that the battery is connected securely. Give the battery a chance to charge.
3. From the top-level display, have a partner go around the house and trip each sensor one at a time. The display should indicate the correct zone "NOT RDY" when the zone is tripped, then return to "SYSTEM OK" when the zone is secured. Be sure that the zone type indicated (ENTRY/EXIT, PERIMETER, ETC.) is correct for the zone being tested.
4. If the zone being checked is armed, (i.e. PANIC or TAMPER, which is always armed) the alarm will be activated. Press OFF and 1111 (or the current code to silence the alarm), or bypass the PANIC and TAMPER zone(s) before you start.
5. Reconnect the siren. Be sure that no one is standing near a siren. Activate the alarm, and ensure that the siren is activated.

FIRE ZONE CHECK OUT

1. Press ' * ' to return the console to the SYSTEM OK indication. Check the fire zone per the sensor manufacturer's instructions. The fire alarm should be activated (three pulse temporal pattern).
2. Press ' * ' to silence the alarm. The display will still indicate that the FIRE ZONE is NOT READY.
3. Press DAY or NIGHT or AWAY and the code to arm the system, then OFF and the User code to disarm. This arm/disarm cycle will reset the smoke detector. If the cause for alarm (i.e. smoke) has cleared, the display will return to SYSTEM OK.

HOME CONTROL CHECKOUT

1. Confirm that the HOUSE CODE on the OmniLT is set to the same HOUSE CODE set on all of the modules.
2. On the console press 4, 1 (ALL ON). All lamp type modules should go on. Note that appliance modules and outputs do not respond to ALL ON.
3. On the console press 4, 2 (ALL OFF). All modules should go off. Note that outputs do not respond to ALL OFF.
4. Operate each unit number individually and verify that it works. Ensure that outputs are working properly.

CUSTOMER CHECKOUT

After you have completed the system check out and everything works, be sure that the customer knows how to:

1. Disarm/silence the system (OFF, 1111 or current code). **HAVE THE CUSTOMER PRACTICE!**
2. Change the codes.
3. Get the menu over the in-house phones.

You should also:

4. Demonstrate arming and disarming.
5. Demonstrate home control.
6. Demonstrate setup and programming.
7. Deliver the Owner's Manual.
8. If the customer has subscribed to a central monitoring service, this should be explained.

IN CASE OF TROUBLE

CONSOLES

If you experience trouble that seems to be with a console, try disconnecting the console and running the console self test as described under CONSOLE HOOKUPS in this manual. If the console does not run the self-test properly, it should be returned to HAI for repair.

"NO CONTROLLER DATA" or erratic operation of the LCD display could be a result of the Green and Yellow wires connected backwards or poorly. If two consoles are connected, make sure that the consoles have different addresses.

CONTROLLER

Check the AC ON (bottom) LED. If it is not lit, check for 16.5 VAC at the transformer connections.

Check the STATUS (middle) LED on the controller board. It should be blinking once per second, indicating the proper operation of the microprocessor and memory. If not, try powering the system down: Disconnect the power transformer and battery, then reconnect both. The status light should begin blinking.

If the AC ON LED is on and the STATUS light is still not blinking, check the AUX 12V with a DC voltmeter. It should be 13.7 volts. If not, make sure that there isn't too much load on the system. Disconnect all loads. If the STATUS LED still won't blink, there is a problem with the controller board and it must be returned to HAI for repair.

Phone line problems, or problems with the OmniLT voice are usually the result of the RJ31X jack being improperly wired. Check RJ31X jack wiring and polarity carefully, as described in TELEPHONE CONNECTIONS.

In the event that the controller is found defective, the controller board should be removed and returned for repair.

Follow this procedure for removing the controller board:

1. If possible, upload the programs and configuration (this will not be possible if the status LED isn't flashing or if you can't get the voice to work).
2. Unplug the power transformer and disconnect the battery
3. Disconnect the RJ31X cable at the jack!! (If you only disconnect it at the OmniLT controller, the house phones won't work.)
4. Disconnect the X-10 cable.
5. Disconnect all wires connected to the terminal strips (TB1, TB2, and TB3).
6. Remove 4 screws; 2 on the top edge, 2 on either side directly above the terminal strip. Remove the controller board.
7. Protect the back of the controller board with cardboard and pack carefully. HAI will not be responsible for returned items damaged due to inadequate packaging.

8. Call your distributor with the serial number for a return authorization number. Write the RA# on the outside of the package.
9. Return the controller to HAI. Include your return address, any special shipping instructions and daytime phone number so that we can reach you if we have any questions. Also include a brief description of the problem that you are having.
10. INSTALLATION: Follow the POWER UP and CHECK OUT procedures in this manual.

FOR HELP: Call HAI, between the hours of 9:00 AM and 5:30 PM Central time, at (800) 229-7256.

X-10 TROUBLESHOOTING TIPS

1. If any light does not work, check the HOUSE CODE on the module. It must be set to the same house code as the OmniLT.
2. Operate the module locally to ensure that power is getting to it. You should be able to turn the light or appliance on using its switch (turn it on, then off, then on again for plug in modules, press the on/off switch for wall switch modules).
3. Three-way wall mounted lamp switches must be installed using the exact procedure described in their instruction sheet. The key to success with three-way wall switches is to identify the wire that was connected to the COMMON terminal of the old manual switches and to following the instructions precisely.
4. Modules that work intermittently from the OmniLT but reliably locally usually have a problem "hearing" the X-10 signal over the power lines. Some tips:
 - Make sure connections to the modules and to the TW523 interface are tight. Loose fuses, wrenuts, circuit breakers, terminal blocks, corrosion, etc. can sometimes inhibit the X-10 signal.
 - Run a separate wire from the OmniLT controller directly to the fuse or breaker panel to ensure that the X-10 signal has a clear path to the panel where it can be distributed to the other circuits. Try changing the phase that the system is on.
 - Items such as electric heaters (resistive loads) and power filters (capacitive loads) tend to absorb the X-10 signal. Try relocating them, if possible.
 - Interference from neighboring systems can be solved by changing the house code to a different one from the neighboring system.
 - Identify any devices that could be transmitting a continuous signal on the powerlines. Wireless intercoms locked in the transmit mode will prevent X-10 signals from getting out. These are not compatible with X-10.

DIGITAL COMMUNICATOR

The OmniLT digital communicator can use Contact ID, or Standard 4/2 or 3/1, (20 pps, 1800 Hz data, 2300 Hz handshake), or (10 pps, 1900 Hz data, 1400 Hz handshake), dual round compared format. Any central station with modern equipment can receive these formats. Compatible receivers are Ademco, Radionics, Osborne-Hoffman, Linear, FBI, and Silent Knight. It is up to the installer to verify compatibility.

If the digital dialer does not get a handshake signal from the central station 45 seconds after it begins dialing, it hangs up and tries again. The dialer will try the FIRST PHONE NUMBER 5 times, then go to the SECOND PHONE NUMBER and try that 5 times. After that, the system will indicate COMMUNICATIONS FAILURE on the console display and the digital communicator will not try again until another reportable event occurs.

The digital communicator will not dial out until the DIAL OUT DELAY has expired. If the alarm is canceled prior to the expiration of the DIAL OUT DELAY, no transmission will take place. After the DIAL OUT DELAY has expired, though, all alarm trips will be transmitted followed by a CANCEL code.

When the digital communicator is used, all voice dial outs will be delayed for five minutes after the expiration of the dial out delay to allow time for the central station to call the premises after an alarm code has been sent. If the digital communicator is unable to successfully communicate with the central station, the user will be alerted to the trouble condition. When the system status is requested using the voice, this condition is reported over the phone as "SECURITY PHONE MESSAGE" trouble.

DESCRIPTION OF CONTACT ID

Contact ID reporting allows very specific event codes to be sent to the central station. A complete report takes under three seconds. Contact ID reporting uses predefined event codes that allow the central station to quickly identify the condition being reported. The specific security zone or user code is identified as part of the report.

For each event code transmitted, the report also includes an event qualifier that identifies whether the report is for a new event (such as a security zone trip), or a restoration of an event (such as a security zone no longer tripped). Trouble conditions are reported, as well as restoration of these trouble conditions. For security armings and disarmings, this event qualifier is also used to identify whether the report is for an arm or disarm. The reporting format for Contact ID is listed in Appendix A in this manual.

When using Contact ID, the alarm codes and/or reporting format cannot be changed. All alarm trips, regardless of Zone Type (except Auxiliary Inputs), will be reported to the Central Station.

DESCRIPTION OF 4/2 FORMAT

The 4/2 format consists of a four-digit account code, from 0000 to FFFF and a two-digit alarm code from 00 to FF. When the digital communicator calls the central station receiver, the latter answers and sends a brief 2300 Hz tone or a 1400 Hz tone called a "Handshake" tone. The digital communicator then reports digits of the account and alarm codes as bursts of either (1800 Hz) or (1900 Hz) tone; the digit 8 is represented by eight bursts of tone. A message, or "round" consists of an account code and an alarm code. Two rounds are sent, and two consecutive rounds must match at the receiver. If they do, the central station receiver sends another brief 2300 Hz or 1400 Hz tone to acknowledge to the digital dialer that the message has been properly received. If the rounds don't match, the receiver does not send the second tone and the digital dialer tries again, up to 5 times. If the rounds are not acknowledged after 5 tries, the digital dialer hangs up and tries the entire call again.

The digital communicator can report alarm zone trips, alarm cancels, low battery, and fire zone trouble. It may also be setup to generate an automatic test signal at periodic intervals. The communicator may be setup to call second phone number using a second account number in the event that it is unable to communicate successfully using the first phone number and account.

The digital communicator is setup at the factory to transmit a code when the battery is low or trouble with the fire zone is detected. If these codes are set to 0 or 00, no code will be sent when the trouble condition is detected.

Although the alarm codes can be changed, we recommend that the alarm codes setup at the factory be used to minimize the risk of installer error in programming the digital communicator. Simply enter the phone numbers and account codes, then verify the alarm codes.

3/1 FORMAT

Older central stations may require a 3/1 format. To use 3/1 format, both account numbers must be changed to 3 digit codes and EVERY alarm code must be changed to a 1-digit code. Do not mix code lengths!

OPENING AND CLOSING REPORTS

The OmniLT system can send opening and closing reports by user to the central station.

When the system is disarmed by user code 1-8, the communicator can call the central station and report that the system was disarmed (opened) with the user code that was used.

When the system is armed by user code 1-8, the communicator can call the central station and report that the system was armed (closed) with the user code that was used.

If the system is disarmed by any other method other than one that requires a user code (i.e. Keyswitch or Scheduled Program), the communicator will send a generic OPEN report to the central station. The code that is sent is defined as OTHER OPEN. If the system is armed by any other method other than one that requires a code (i.e. Quick Arm, Keyswitch, or Scheduled Program), the communicator will send a generic CLOSE report to the central station. The code that is sent is defined as OTHER CLOSE.

DEFAULT REPORTING CODES FOR 4/2 FORMAT

CODE	ZONE
98	TEST CODE
01	ZONE 1
02	ZONE 2
03	ZONE 3
04	ZONE 4
05	ZONE 5
06	ZONE 6
07	ZONE 7
08	ZONE 8
09	ZONE 9
10	ZONE 10
11	ZONE 11
12	ZONE 12
13	ZONE 13
14	ZONE 14
15	ZONE 15
16	ZONE 16
17	ZONE 17
18	ZONE 18
19	ZONE 19
20	ZONE 20
21	ZONE 21
22	ZONE 22
23	ZONE 23
24	ZONE 24
25	ZONE 25

CODE	ZONE
81	FREEZE ALARM
82	FIRE EMERG
83	POLICE EMERG
84	AUX EMERG
85	DURESS ALARM
86	BATTERY LOW
87	FIRE ZN TRBL
99	CANCEL
40	OTHER OPEN
41	USER 1 OPEN
42	USER 2 OPEN
43	USER 3 OPEN
44	USER 4 OPEN
45	USER 5 OPEN
46	USER 6 OPEN
47	USER 7 OPEN
48	USER 8 OPEN
60	OTHER CLOSE
61	USER 1 CLOSE
62	USER 2 CLOSE
63	USER 3 CLOSE
64	USER 4 CLOSE
65	USER 5 CLOSE
66	USER 6 CLOSE
67	USER 7 CLOSE
68	USER 8 CLOSE

INSTALLER SETUP

This section describes the items that the installer must setup as part of system installation. The Installer Setup mode is used to configure the general operation of the system, the Outputs, the Zone Types, and the Digital Communicator. This information is covered only in this manual. All other SETUP items, including delay times, zone and unit names, voice dialer, and codes are covered in the Owner's Manual, Document No. 21R00-1.

SETUP items are stored permanently in the system, even if the battery and AC power are disconnected. The "default" settings are the ones that have been set at the factory. You can review or change the setup items easily, as shown below.

Note: The default Installer Code is 1111.

To enter the Installer SETUP menu, press 9, and the installer code to get the Setup Menu, then press the # (INST) key.

```
INSTALLER SETUP MENU:
1=CTRL  2=ZONE  3=DCM  ↓
5=TEMP  6=MISC  7=EXP  ↑
```

SETUP CONTROL

To setup the X-10 and Outputs, from the Installer Setup menu, select the 1 (CTRL) key. The X-10 house code must be specified, as well as the output type for each of the Outputs. The output type for the Bell output may also be changed.

Press (↓) to advance to the next item, (↑) to go back.

X-10 HOUSE CODE

The X-10 House Code is the house code for units 1-16:

```
X-10 HOUSE CODE:      A
1-16=A-P              ↓
```

X-10 3-PHASE

This setting is used to select whether the X-10 signal is transmitted only at zero crossing for single phase (120V/240V) electrical systems or is transmitted at 0, 60, and 120 degrees for three phase electrical systems.

```
X-10 3-PHASE:        0
0=NO 1=YES           ↓
```

When set to No, the burst at 60 and 120 degrees will be eliminated. The default setting for 3-Phase is No.

OUTPUT TYPES

An output type must be specified for each of the outputs and for the Bell output.

```
OUTPUT 1 TYPE:        0
GENERAL PURPOSE #=CHNG ↓
THROUGH
EXP OUTPUT 8 TYPE:   0
GENERAL PURPOSE #=CHNG ↓
THERMOSTAT OUTPUT:   0
THERMOSTAT          #=CHNG ↓
BELL OUTPUT:         6
INT SNDR            #=CHNG ↑
```

OUTPUT TYPE	NUMBER	DESCRIPTION
GENERAL PURPOSE	0	General Purpose Output
OK TO ARM	1	OK To Arm
ARMED	2	Armed
PRE-ALM SNDR	3	Pre-Alarm Sounder
INT SNDR	4	Interior Sounder
INT BURG SNDR	5	Interior Burglary Sounder
INT FIRE SNDR	6	Interior Fire Sounder
EXT SNDR	7	Exterior Sounder
EXT BURG SNDR	8	Exterior Burglary Sounder
EXT FIRE SNDR	9	Exterior Fire Sounder
BURG COMM	10	Burglary Communicator
FIRE COMM	11	Fire Communicator
AUX COMM	12	Auxiliary Communicator
SWITCHED POWER	13	Switched Power Output

For output types, the current setting is shown on the bottom line. Press the '#' key to select a new type from a list of output types. The display shows:

```

SELECT TYPE:      6
INT SNDR         ↓

```

Use the arrow keys to scroll through the list, or select the appropriate output type number. Then press '#' to enter the new type.

SETUP ZONES

To setup the zone type for each security zone, from the Installer Setup menu, select the 2 (ZONE) key.

WIRELESS RECEIVER

A Wireless Receiver can be used to add 16 zones (9-24) to the OmniLT. If used, you must enable the following item:

```

WIRELESS RECEIVER:  0
0=NO 1=YES         ↓

```

NOTES:

1. If the Model 22A00 Expansion Module is used, it must be configured under Setup | Installer | Expansion.
2. If a Wireless Receiver is used and the 22A00 Expansion Module is also connected, all 16 zones (9-24) will be wireless zones. Outputs 1-8 (Units 17-24) on the Expansion Module may be used; however the zones will be inactivated.

ZONE RESISTORS

This item is used to specify if the 1000-ohm end-of-line zone resistors will be used with zone inputs other than Supervised Fire and Gas. If this item is set to "Yes", all zones will require an end-of-line resistor. The default setting is "Yes".

```

ZONE RESISTORS:    1
0=NO 1=YES        ↓

```

Z 1 TYPE THROUGH Z 25 TYPE

This item specifies the zone type for each zone.

```

ZONE 1 TYPE:      64
AUXILIARY        #=CHNG ↓
THROUGH
ZONE 25 TYPE:    64
AUXILIARY        #=CHNG ↑

```

The current Zone Type setting is shown on the bottom line. To change a zone type, use the arrow keys to scroll through the list of zone types then press '#' to select a new type. The display shows:

```

SELECT TYPE :          1
PERIMETER             ↑
  
```

ZONE RESPONSE TIME

All zones, in the OmniLT are set to 300 milliseconds fixed response time.

ZONE TYPES

ZONE TYPE	NUMBER	DESCRIPTION
ENTRY/EXIT	0	Entry/Exit
PERIMETER	1	Perimeter
NIGHT INT	2	Night Interior
AWAY INT	3	Away Interior
2X ENTRY DELAY	4	Double Entry Delay
4X ENTRY DELAY	5	Quadruple Entry Delay
LATCH PERIM	6	Latching Perimeter
LATCH NIGHT INT	7	Latching Night Interior
LATCH AWAY INT	8	Latching Away Interior
PANIC	16	Panic
POLICE EMERG	17	Police Emergency
SILENT DURESS	18	Duress
TAMPER	19	Tamper
LATCH TAMPER	20	Latching Tamper
FIRE	32	Fire
FIRE EMERG	33	Fire Emergency
GAS	34	Gas Alarm
AUX EMERG	48	Auxiliary Emergency
TROUBLE	49	Trouble
FREEZE	54	Freeze
WATER	55	Water
FIRE TAMPER	56	Fire Tamper
AUXILIARY	64	Auxiliary
KEY SWITCH	65	Keypad Input
ENERGY SAVER	80	Programmable Energy Saver Module
OUTDOOR TMP	81	Outdoor Temperature
TEMPERATURE	82	Temperature
TEMP ALARM	83	Temperature Alarm

LATCHING ZONE TYPES

LATCHING ZONE TYPES ignore the status of that zone during power cycles.

If the FIRE ALARM VERIFICATION feature is being used, any device (other than FIRE or GAS) connected to an output configured as a Switched Output (i.e. Glassbreak Detectors), must be connected to a zone configured as a LATCHING ZONE TYPE (latching perimeter, latching night interior, latching away interior, and latching tamper).

DESCRIPTION OF ZONE TYPES

ENTRY/EXIT

ENTRY/EXIT ZONE types are intended for doors. ENTRY/EXIT ZONES are armed in security modes DAY, NIGHT, AWAY, and VACATION. In DAY and AWAY modes, there is an entry delay (defined by ENTRY DELAY) on ENTRY/EXIT ZONES to allow you to get into the house and turn off the alarm before it sounds. In NIGHT & DAY INSTANT mode, there is no entry delay, so that the alarm sounds immediately if someone opens a door.

There are two special types of ENTRY/EXIT ZONES for use with garage doors, or doors that are far away from the control console. They are called DOUBLE ENTRY DELAY and QUADRUPLE ENTRY DELAY zones. These zones have double or quadruple the ENTRY DELAY to give you additional time to reach the console to disarm the system upon returning. Only the ENTRY DELAY is extended on these zone types. The EXIT DELAY is not extended.

If an ENTRY/EXIT ZONE is tripped first, all other zones will also be delayed.

PERIMETER and LATCHING PERIMETER

PERIMETER ZONE types are intended for windows and exterior doors not requiring an entry delay. All PERIMETER ZONES are armed in security modes DAY, NIGHT, AWAY, and VACATION. There is not an entry delay on a perimeter zones. If a window or door on this zone is opened while the security system is in DAY, NIGHT, AWAY or VACATION mode, the alarm will sound immediately. LATCHING PERIMETER ZONES ignore the status of that zone during power cycles.

NIGHT INTERIOR and LATCHING NIGHT INTERIOR

NIGHT INTERIOR ZONES are intended for motion detectors in areas where no one should be while you are sleeping in your home. For example, if you have a two-story home and sleep upstairs, your downstairs motion detector(s) should be on a NIGHT INTERIOR ZONE.

NIGHT INTERIOR ZONES are armed in security modes NIGHT, VACATION, and AWAY only. There is no delay on a NIGHT INTERIOR ZONE. Night interior zones are NOT armed in DAY or DAY INSTANT mode, so that you may move about freely in your home when the security system is in DAY or DAY INSTANT mode, while still having the windows and doors protected. LATCHING NIGHT INTERIOR ZONES ignore the status of that zone during power cycles.

AWAY INTERIOR and LATCHING AWAY INTERIOR

AWAY INTERIOR ZONES are for areas of your home where no one should be while you are away. In the previous example, your upstairs motion detector(s) should be on an AWAY INTERIOR ZONE. AWAY INTERIOR ZONES are armed only when the security mode is AWAY. LATCHING AWAY INTERIOR ZONES ignore the status of that zone during power cycles.

PANIC, TAMPER, and LATCHING TAMPER

PANIC and TAMPER ZONES are for emergency pushbuttons and tamper switches. PANIC and TAMPER ZONES are ALWAYS ARMED, even if the security mode is OFF. There are no delays on PANIC and TAMPER ZONES, however, the OmniLT waits the DIAL OUT DELAY before dialing out.

TAMPER ZONES should be used for items such as gun cabinets and liquor closets.

LATCHING TAMPER ZONES ignore the status of that zone during power cycles.

POLICE EMERGENCY

This zone type activates the burglar alarm and sounder. An emergency dial out is activated after the DIAL OUT DELAY.

DURESS EMERGENCY (SILENT DIAL OUT)

If you wish to have a button in your home that activates a SILENT dial out, (no lights flashing and no sounder) it should be connected to a zone that is configured as a DURESS EMERGENCY. If this zone is accidentally tripped, you will not know that the OmniLT is making a silent dial out, and hence won't know to stop it.

To stop a silent dial out once it has started, you must go to the console and press OFF then enter your code.

SUPERVISED FIRE

Any zone in the OmniLT can be programmed as a SUPERVISED FIRE ZONE, however, only Zone 8 can be configured as a UL Supervised Fire Zone. In UL Listed Installations, all fire detectors must be configured as a SUPERVISED FIRE ZONE and connected to Zone 8 as shown in this manual. When Zone 8 is configured as a SUPERVISED FIRE ZONE, the Zone 8 Jumper (J9) must be set to the SMK (smoke) position.

FIRE EMERGENCY

This zone type activates the fire alarm for a normally closed (open for alarm) and open collector (short to ground for alarm) switches. It is not supervised as required for UL Listed Installations and shall NOT be used in such installations.

GAS

This GAS ZONE will generate an alarm, activate the sounder (on - off - on - long off), and make a dial out. This zone type requires an external 1000-ohm end-of-line resistor. When Zone 8 is configured as a GAS ZONE, the Zone 8 Jumper (J9) must be set to the SMK (smoke) position.

AUXILIARY EMERGENCY

This AUXILIARY EMERGENCY ZONE type will generate an alarm (console beeper - no sirens) and make an emergency dial out when the zone is violated.

TROUBLE

This zone type can be used to monitor the status of an external device, such as the battery status of a wireless security receiver. It can also be used to record events in the event log (i.e. driveway activation, opening of a gate, etc.) without setting off the alarm.

When the zone is open, the zone name will be displayed on the display as "NOT RDY". The alarm is not activated, regardless of the security mode. The trouble is logged in the event log. The digital communicator (if used) will report the alarm code for the zone. The voice dialer will not be activated.

FREEZE

This FREEZE ALARM ZONE type will generate an alarm (console beeper, no sirens) and make an emergency dial out.

WATER

This WATER ALARM ZONE type will generate an alarm (console beeper, no sirens) and make an emergency dial out.

FIRE TAMPER

This zone type is used to monitor the wiring to bells and sirens (other than those connected to the Bell Output). The zone will report trouble if an open, short, or other wiring problem is detected in the supervised bell circuit. This zone will make a digital dial out when violated. Connect a wire from the Fire Tamper zone to an output configured as a Sounder.

AUXILIARY

A zone defined as AUXILIARY is ignored for security. It is used to activate macros or to conditionalize programs. This is the default setting for all zones. Zones that are not in use should be configured as AUXILIARY.

KEYSWITCH INPUT

This zone is used to arm AWAY and disarm the OmniLT security system using a toggle (to ground) keyswitch or keypad.

PROGRAMMABLE ENERGY SAVER MODULE

This zone type is for use with the PESM. It converts the Zone and the corresponding Output to operate the PESM. Only Zones 7-16 can be programmed as PESMs.

OUTDOOR TEMPERATURE

Use this zone type for Outdoor Temperature Sensors.

TEMPERATURE

The general-purpose TEMPERATURE ZONE type is typically used to monitor indoor temperatures and control devices. It sets the zone secure/not ready for program conditionals and event button activation.

If FREEZE ALARM is enabled, it reports a potential freeze condition if the temperature falls below 40°.

TEMPERATURE ALARM

The TEMPERATURE ALARM ZONE type will generate an alarm (console beeper, no sirens) and dial out if the temperature goes above the high setpoint or drops below the low setpoint.

NOTE ON TEMPERATURE ZONE TYPES

Outdoor temperature, temperature, and temperature alarm zone types all have HEAT and COOL setpoints. The zone is "not ready" if the temperature is above the high setpoint OR below the low setpoint. The zone is "secure" if the temperature is between the setpoints. Setting a setpoint to 0 disables the setpoint.

Except for a type 83, the alarm is not activated. The zone "not ready" or "secure" status is used to activate button programs and program conditionals.

SETUP DIGITAL COMMUNICATOR

To setup the Digital Communicator, from the Installer Setup menu, select the 3 (DCM) key.

FIRST PHONE NUMBER, FIRST ACCOUNT NUMBER

The first item in the DIGITAL COMMUNICATOR category is the FIRST PHONE NUMBER. Enter the FIRST PHONE NUMBER on the keypad. This enables the Digital Communicator. You can cause a 2-second pause during dialing by pressing the DAY key. Press '#' when done.

```
FIRST PHONE NUMBER :  
-                      ↓
```

To disable the digital communicator, enter a single "-" for the FIRST and SECOND PHONE NUMBER by pressing the OFF key, then '#'. Phone number may be up to 24 digits long.

Press the down arrow (↓) to advance to the FIRST ACCT NUMBER:

```
FIRST ACCT NUMBER:  0000  
0-FFFF             ↓
```

Enter the 4 digit account number (3 digits if using 3/1 format) and press '#'. To enter the digits B-F, first press the OFF key, then press the 1-5 key respectively (i.e. 1B11 = 1 OFF 1 1 1 #).

NOTE: You must enter 4 digits for the account number if you are using Contact ID or a 4/2 format (i.e. 0123), and 3 digits if using 3/1 (i.e. 123).

SECOND PHONE NUMBER, SECOND ACCOUNT NUMBER

Enter these if used.

```
SECOND PHONE NUMBER :  
-                      ↓  
  
SECOND ACCT NUMBER:  0000  
0-9999             ↓
```

COMMUNICATOR TYPE

This item is used to select the transmitting parameters of the digital communicator. The OmniLT can transmit in FAST 2300 Hz (20 PPS) mode, in SLOW 1400 Hz (10 PPS) 3/1 format, and in Contact ID.

```
COMMUNICATOR TYPE:      2
0=2300 1=1400 2=ID      ↓
```

The default setting is 2 = ID (Contact ID). If you need to transmit to a 4/2 or 3/1 receiver, select the proper handshaking frequency (2300 Hz or 1400 Hz) and press '# '.

TWO-WAY AUDIO

If a Two-Way Audio Module is being used, this item enables hands free audio communication between your customer's premises and the central station. After the transmission of the alarm to the central station, the operator can talk and listen to people and sounds at the premises.

```
TWO-WAY AUDIO:          0
0=NO 1=YES              ↓
```

If a Two-Way Audio Module is part of the system, select the 1 (YES) key to enable this feature.

REPORT OPEN/CLOSE

The communicator can be setup to send an opening and a closing report by user code. Whenever the system is disarmed the communicator will send an opening report to the central station. When the system is armed, the communicator will send a closing report to the central station.

```
REPORT OPEN/CLOSE:      0
0=NO 1=YES              ↓
```

To enable the communicator to send opening and closing reports to the central station, select the 1 (YES) key.

AUTOMATIC TEST TIME

The communicator CAN be setup to automatically send a test code to the central station on a periodic basis. AUTOMATIC TEST TIME is used to set the time and days of the week of the test, and the TEST CODE specifies the code that will be transmitted for the test.

```
AUTOMATIC TEST TIME:
--      NEVER  #=CHNG↑
```

To disable the automatic test, press the '# ' key and then 0 for Never, and '# '. If you are using PC Access, deselect all days under the heading "Test time".

When using a 4/2 or 3/1 format, the digital communicator will send the designated Test Code. The default Test Code is 98.

```
TEST CODE:              98
0-FF                    ↓
```

ALARM CODES (4/2 and 3/1 Formats)

Press the down arrow (↓) to advance to the next ZONE ALARM CODE. Press the up arrow (↑) to go to the previous ZONE ALARM CODE. To change an alarm code, enter two digits for 4/2 format, or one digit when using 3/1 format, then press '# '.

Enter the 2 digit alarm code (1 digit if using 3/1 format) and press '# '. To enter the digits B-F, first press the OFF key, then press the 1-5 key respectively (i.e. B1 = OFF 1 1 # and CB = OFF 2 OFF 1 #).

The various alarm codes are sent when the indicated alarm zone is tripped. Each alarm code must be two digits long for 4/2 format (01-FF), 1 digit for 3/1 format (1-F).

To disable the digital communicator for a specific zone, set the alarm code to 0 or 00. The digital dialer will not report when this zone is tripped.

ZONE 1 ALARM CODE: 01
0-FF ↓

THROUGH

USER 8 CLOSE CODE: 68
0-FF ↑

SETUP TEMPERATURES

To configure temperatures from the Installer Setup Menu, press the 5 (Temp) key.

TEMPERATURE DISPLAY

This allows you to choose between Fahrenheit or Celsius temperature format.

TEMPERATURE DISPLAY: 1
1=FAHRENHEIT 2=CELSIUS ↓

THERMOSTAT TYPE

If thermostats are part of the system, this item specifies the thermostat type for each thermostat (this enables the thermostat).

For thermostat types, the current setting is shown on the bottom line.

THERMOSTAT 1 TYPE: 1
AUTO HEAT/COOL #=CHNG ↓

THERMOSTAT 2 TYPE: 0
NOT USED #=CHNG ↑

To change a thermostat type, use the arrow keys to scroll through the list of thermostat types, then press '#' to select a new type.

TYPE	NUMBER	DESCRIPTION
AUTO HEAT/COOL	1	Automatic changeover heat and cool thermostat
HEAT/COOL	2	Manual changeover heat and cool thermostat
HEAT ONLY	3	Heating only thermostat
COOL ONLY	4	Cooling only thermostat
SETPOINT ONLY	5	Setpoint only thermostat

SETUP MISCELLANEOUS

To configure the miscellaneous installer setup items, from the Installer Setup menu, press the 6 (MISC) key.

INSTALLER CODE

The Installer code allows the installer access to the Installer Setup menu. The Installer code should be changed and not given to the customer. The Installer code can not be used for remote phone access.

INSTALLER CODE :
0000-9999 0000=DISABLE↓

The default setting for the Installer code is 1 1 1 1.

NOTE:

Remember this Installer code and do not disable. There is no way to reset or retrieve the code! If the code is forgotten or disabled, the OmniLT controller must be sent back to the factory. Call for an RA#.

ENABLE PC ACCESS

This enables or disables the PC ACCESS feature. Factory default is enabled.

ENABLE PC ACCESS : 1
0=NO 1=YES ↓

PC ACCESS CODE

This code allows dealers to put an access code in the system that is separate from the customer's Master code and the Installer code. Dealers can use the PC Access code to access the system by PC. The PC Access code cannot arm and disarm the system. The PC Access code is NOT programmed from the factory. To use it, set it to any code other than 0000. To disable the PC Access code, enter 0000 for the code.

PC ACCESS CODE :
0000-9999 0000=DISABLE↑

CALL BACK PHONE NUMBER

In response to a request for remote PC ACCESS using the PC ACCESS code, the system will hang up and dial this number back immediately. To program the CALLBACK PHONE NUMBER, enter the number then press '#'. To remove the CALLBACK PHONE NUMBER, press the OFF key to enter a single "-", then press '#'.

CALL BACK PHONE NUMBER :
- ↓

OUTSIDE SIREN DELAY

If an output is configured as an "Exterior Sounder", when the alarm is "tripped", the interior sounder is turned on first. After the OUTSIDE SIREN DELAY, the outside sounder is turned on.

This feature helps reduce annoying false alarms by signaling inside the premises first. The outside siren delay is set to 15 seconds at the factory. You may change it to any value from 0 to 60 seconds. If you want the outside sounder to turn on immediately when the alarm is activated, set the delay to 0. We recommend a minimum time of 15 seconds.

DIAL OUT DELAY : 15
0-60 SECONDS ↓

DIAL OUT DELAY

The DIAL OUT DELAY is the number of seconds that the OmniLT waits before making an emergency dial out, AFTER the alarm is "tripped" (activated by burglar or fire). This delay is set at the factory to 15 seconds. We recommend a minimum time of 15 seconds to preclude an accidental activation of the alarm from calling in a false alarm.

DIAL OUT DELAY: 15
0-60 SECONDS ↓

ALARM RESET TIME

The Alarm Reset Time is the time it takes before the alarm system resets itself after the alarm is tripped.

ALARM RESET TIME: 4
1-30 MINUTES ↓

To change the alarm reset time, enter a new time between 1-30 minutes, then press the '#' key. The default setting is 4 minutes.

ARMING CONFIRMATION

The Arming Confirmation is a quick pulse (squawk) given by the exterior siren when the alarm system is armed into a security mode and the EXIT DELAY is expired.

ARMING CONFIRMATION: 0
0=NO 1=YES ↓

To enable the arming confirmation feature, press the 1 (YES) key, then press the '#' key. The default setting is disabled.

FIRE ALARM VERIFICATION

This unit is equipped with a FIRE ALARM VERIFICATION feature. When a zone configured as a FIRE (Type 32) or a GAS (Type 34) is activated, the system will cycle the SWITCH 12V Output off for 10 seconds. The SWITCH 12V Output will then be restored, and 5 seconds later, the zones will be monitored again. If the zone is activated again within a 2-minute window, the fire alarm will be activated. If not, no fire alarm will be indicated.

VERIFY FIRE ALARMS: 1
0=NO 1=YES ↓

NOTE:

If VERIFY FIRE ALARMS is turned ON, **any** device (other than FIRE or GAS) connected to a SWITCH 12V Output (i.e. Glassbreak Detectors), must be connected to a zone configured as a LATCHING ZONE TYPE.

This feature is designed to reduce false alarms and is turned ON by factory default. The following notice is required by UL:

WARNING

This unit includes an alarm verification feature that will result in a delay of the system fire alarm signal from the initiating circuit. The total delay (OmniLT controller plus detector delay) shall not exceed 60 seconds. No other initiating devices shall be connected to these circuits unless approved by the local authority having jurisdiction.

Zone Circuit	Control Unit Delay	Detector Model/Delay	Total Delay
_____	: 10 seconds	+ _____	= _____
_____	: 10 seconds	+ _____	= _____
_____	: 10 seconds	+ _____	= _____
_____	: 10 seconds	+ _____	= _____

SUPERVISE BELL

This enables or disables supervision of the Bell Output, which monitors the wiring to bells and sirens. Factory default is disabled.

SUPERVISE BELL: 0
0=NO 1=YES ↓

ENABLE EMERGENCY KEYS

This enables or disables the functionality of the emergency keys on the console keypad. Factory default is enabled.

ENABLE EMERG KEYS: 1
0=NO 1=YES ↓

TIME DISPLAY

This allows you to choose between AM/PM or 24 HOUR time format.

TIME DISPLAY: 1
1=AM/PM 2=24HR ↓

DATE DISPLAY

This allows you to choose between MONTH/DAY or DAY/MONTH date format.

DATE DISPLAY: 1
1=MMDD 2=DDMM ↓

AC POWER FREQUENCY

Set this to the appropriate AC Powerline Frequency.

AC POWER FREQUENCY: 1
1=60HZ 2=50HZ ↓

DEAD LINE DETECT

NOTE: To disable OmniLT from detecting a dead line, set this item to '0'; otherwise adjust only under direction of HAI.

This item adjusts the threshold that is used to determine when the phone line goes dead.

DEAD LINE DETECT: 8
0-15 0=DISABLE ↓

OFF HOOK DETECT

NOTE: Adjust only under direction of HAI.

This item adjusts the threshold that is used to determine when the phone line is going off hook.

OFF HOOK DETECT: 69
20-250 ↓

PICKUP AFTER HANGUP

This item is used to disable OmniLT from picking up the phone line after the called party hangs up the line.

PICKUP AFTER HANGUP: 1
0=NO 1=YES ↓

Currently, after the called party or the called party's answering machine hangs up the phone line, OmniLT picks up the line and make its "Beep". The default setting for Pickup After Hangup is Yes.

CLOCK ADJUSTMENT

If the clock on an OmniLT is running faster or slower than the actual time, you can have the OmniLT automatically compensate up to 29 seconds per day. The OmniLT will add or subtract the selected amount of time daily.

```
CLOCK ADJUSTMENT:      30
1-59=-29 TO +29 SEC/DAY↑
```

Enter 1-29 to subtract 1-29 seconds. Enter 31-59 to add 1-29 seconds. Enter 30 for no adjustment to the clock. The default setting is 30.

MODEL AND SOFTWARE VERSION

The model number and software version for the system is displayed:

```
HAI OMNI LT
S/W VERSION 1.8      ↓
```

RESET SYSTEM EEPROM

Select the 1 (YES) key to reset the EEPROM. All programs, names, and setup items will be reset. All system RAM will also be initialized and the system will restart. This option, if effect, allows the system to be restored to factory fresh configuration.

```
RESET SYSTEM EEPROM?  0
0=NO  1=YES           ↓
```

RESET SYSTEM RAM

Select the 1 (YES) key to cause all of the system RAM to be reinitialized. The time, date, and event log will be cleared. Other volatile memory locations will also be reinitialized. The system RAM should only be reset if the system is acting strangely and memory corruption is suspected. Resetting the system RAM will not reset any setup items stored in EEPROM.

```
RESET SYSTEM RAM?    0
0=NO  1=YES          ↑
```

SETUP EXPANSION

To configure each expansion module that is installed on the OmniLT, from the Installer Setup menu, press the 7 (EXP) key.

MODULE 1 TYPE

The Module Type defines the function of each expansion module on the controller. Module 1 is the module with the ADDR jumper set to 1. Set the module type from the list below. Press # to change the module type, then use the arrow keys to select the proper module type, then press # to enter.

```
MODULE 1 TYPE        1
NOT USED             #=CHNG ↓
```

Select from the following for the module with jumper set to 1:

MODULE TYPES	NUMBER	DESCRIPTION
NOT USED	0	No module is installed
HARDWIRE EXPNDR	1	Model 22A00 Expansion Module installed
ALC	2	ALC Interface Module installed
OMNI-LINK	3	Model 10A17 Serial Interface installed using Omni-Link protocol

MODULE 2 TYPE - MODULE 4 TYPE

Module 2 is the module with the jumper set to 2, and so on. Set each module type from the list above.

SERIAL 1 RATE

Serial 1 Rate is the baud rate used for the built-in serial interface (J5 Serial) on the OmniLT. Select the baud rate for the built-in serial interface from the list below. Use the arrow keys to select the baud rate then press #.

BAUD RATE	NUMBER	
75 baud	1	
150 baud	2	
300 baud	3	
600 baud	4	
1200 baud	5	
2400 baud	6	
4800 baud	7	
9600 baud	8	(default)

SERIAL 2 RATE

Serial 2 Rate is the baud rate used when a Model 10A17 Serial Interface Module is added to the OmniLT. If a serial interface module is installed, select its baud rate as shown above.

OMNILT SPECIFICATIONS

Size: Controller: 9.1 W x 12.1 H x 3.5 D
Console: 4.6 W x 4.5 H x 1.2 D

Weight: Controller: approx. 4.5 lb.
Console: approx. 0.5 lb.

Operating Ranges: 32 - 122 degrees F (0 - 50 degrees C)
10 - 95 % relative humidity, non-condensing

Power: 120 VAC, 60 Hz, 60 watts

Transformer: 16.5 VAC, 40 VA, 50/60 Hz

Battery: Sealed Rechargeable Lead-Acid, 12 volts

Bell Fuse: Polyfuse: 1.35A

Device Fuse: Polyfuse: .9 A

Output Fuse: Polyfuse: .3 A

Battery Fuse: Polyfuse: 2.5 A

Polyfuses are permanent fuses that do not need replacement.

Nominal Voltage: 10 - 13.8 VDC

Low Voltage Cut Out: approx. 9 VDC

Typical Current Consumption at Nominal Voltage:

Controller: 105 mA
Console: backlight off, 35 mA
backlight on, 100 mA

CONTROLLER OUTPUTS

	UL RATINGS	MAXIMUM
Devices: AUX 12 VDC, CONSOLE, and OUTPUTS 1 and 2:	200 mA	500 mA
Bell: BELL	350 mA	1 A
Outputs: OUTPUTS 1 and 2, each, maximum:	100 mA	100 mA
Backup: Required battery backup hours:	24 hours	
Battery: Recommended Battery:	7 Ah	14 Ah

UNDERWRITER'S LABORATORIES (UL) INSTALLATION REQUIREMENTS

The OmniLT control unit (21A00-1) is suitable for Grade A household burglar and fire applications. Refer to UL1641 for installation requirements.

1. The line carrier (X-10) operation is considered supplementary. Operation of the line carrier devices was not investigated by UL.
2. For those zones programmed as PANIC, DURESS or POLICE EMERGENCY, the initiating device shall be a UL Listed Hold Up Device switch.
3. Connections to phone circuit must be made via the supplied cable and RJ31X Jack as shown under RJ31X JACK CONNECTIONS in this manual.
4. For connection of smoke detectors to the controller, refer to requirements under FIRE ZONE HOOKUP and FIRE ZONE CONNECTIONS diagrams in this manual.
5. For fire detection, maximum current ratings for 24 hours must be observed.
6. Recognized energy limited cable shall be employed, 22 AWG minimum for all connections.
7. The audible signal appliance shall be the Listed Wheelock Model MT-12/24-R Multitone Signal, rated 10.5 - 15.6 VDC, 95 dB(A) with 2 reflecting planes. The audible signal shall be mounted indoors in a central location. The audible signal appliance should be connected to the "BELL" circuit.
8. If used, the OUTSIDE SIREN DELAY shall be set to 0 seconds.
9. If the remote arm/disarm switch is used, it shall be the Listed Ademco Model 9789.
10. Operation of the controls with the Programmable Energy Saver Module was not conducted by UL.
11. Operation of the Model 12A00 Wireless Receiver was not verified by UL.
12. Operation of the Two-Way Audio Module was not verified by UL.
13. Refer to the OmniLT Owner's Manual (Document No. 21R00-1) for programming requirements in UL Listed Installations.
14. For the monitoring of burglar alarm initiating devices, the zone type shall provide an audible output (i.e., not DURESS).
15. The OmniLT controller must be connected (when employed) to listed carbon monoxide gas detectors (i.e. Sentrol -Model 240-CO).
16. All connections to energy sensors and modules must be done to listed Class 2 circuits only.
17. The OmniLT must be used in Residential Applications that are under a single ownership.

When used in UL Listed Installations, the following items apply:

1. The "High Security Mode" must be ON.
2. The "Enable Auto Bypass" must be OFF.
3. The "Zone Resistors" must be YES.
4. The "Supervise Bell" must be YES.
5. The "Beep On Trouble" must be ON.
6. The ENTRY DELAY SHALL NOT EXCEED 45 SECONDS for Residential Applications.
7. The EXIT DELAY shall not exceed 60 seconds.
8. Double Delay and Quad Delay zone types shall not be used.
9. For Residential Applications, the sounding device may be mounted indoors. If, however, the sounding device is connected to a circuit configured as an "Exterior Sounder", the OUTSIDE SIREN DELAY shall be set to 0.
10. Installer: NAME: _____ NUMBER: _____

SMOKE DETECTOR INSTALLATION GUIDELINES

1. Ceiling mounted smoke detectors should be located in the center of the room or hall, or not less than 4 inches from any wall. When the detector is mounted on a wall, the top of the detector should be 4 to 12 inches from the ceiling.
2. Do not install smoke detectors where normal ambient temperatures are above 100 deg. F (37.8 deg. C) or below 40 deg. F (4 deg. C). Also, do not locate the detector in front of air conditioners, heating registers, or other locations where normal air circulation will keep smoke from entering the detector.
3. Additional information on Household Fire Warning is available at nominal cost from: The National Fire Protection Association, Battery March Park, Quincy, MA. 02269. Request Standard No. NFPA 72. Contact your home Insurance Company for a possible reduction of your insurance premium.
4. A smoke detector should be located between the sleeping area and the rest of the family living unit.
5. In family living units with more than one sleeping area, a smoke detector should be provided to protect each sleeping area.
6. A smoke detector should be located on each story (Refer to the diagrams below).
7. For complete details on proper location and installation of smoke detectors, refer to the instructions supplied with the smoke detector.

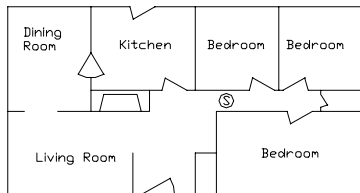

(a) A smoke detector should be located between the sleeping area and the rest of the family living unit.

(b) Where to Locate the Required Smoke Detectors in New Construction. All of the smoke detectors specified in (a) for existing construction are required, and, in addition, a smoke detector is required in each bedroom.

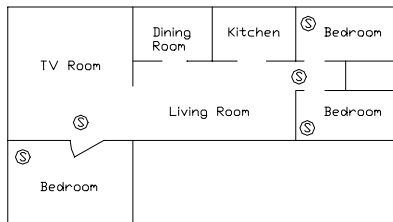

(b) In family living units with more than one sleeping area, a smoke detector should be provided to protect each sleeping area in addition to detectors required in bedrooms.

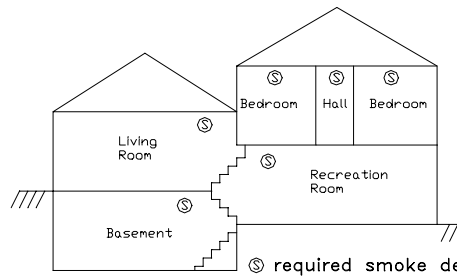

Split level arrangement. Smoke detectors are required where shown. Smoke detectors are optional if door is not provided between living and recreation rooms.

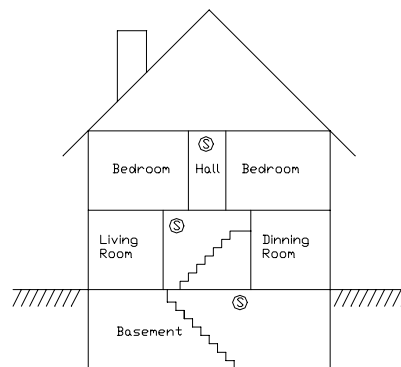

A smoke detector should be located on each story.

APPENDIX A – CONTACT ID REPORTING FORMAT

ZONE TYPE	TRIP	TROUBLE	DESCRIPTION
Entry/exit (also Double & Quad)	134	370	Entry/exit burglary
Perimeter (also Latching)	131	370	Perimeter burglary
Night Interior (also Latching)	132	370	Interior burglary
Away Interior (also Latching)	132	370	Interior burglary
Panic	120	375	Panic alarm
Police Emergency	120	375	Panic alarm
Silent Duress	122	375	Silent panic
Tamper (also Latching)	137	370	Tamper burglary
Fire	110	373	Fire alarm
Fire Emergency	110	373	Fire alarm
Gas	151	373	Gas alarm
Auxiliary Emergency	150	370	24 hour non-burglary
Trouble	330	330	System peripheral trouble
Freeze	159	370	Low temperature alarm
Water	154	370	Water leakage
Auxiliary	none	none	none
Fire tamper	321	321	Bell/siren #1 trouble
Temperature Alarm	152	370	Refrigeration alarm

EVENT	CODE	DESCRIPTION
Zone bypass/restore	570	Zone bypass/restore
Fire zone bypass/restore	571	Fire bypass/restore
Automatic communicator test	602	Periodic test
Cancel	406	Cancel
User disarm/arm	401	Open/close by user
Programmed disarm/arm	403	Automatic open/close
PC Access disarm/arm	407	Remote open/close
Quick arm	408	Closing-quick arm
Keyswitch disarm/arm	409	Keyswitch open/close

SYSTEM TROUBLE	CODE	DESCRIPTION
Battery low	302	Low system battery
Fuse	312	Power supply overcurrent
AC power failure	301	AC power loss
Phone line dead	351	Phone line #1 trouble
Digital communicator	350	Communication failure
Fire tamper	321	Bell/siren #1 trouble



HAI • New Orleans, LA • U S A